

Snow **Drive**[®]

TRACTION DEVICES

by **LAMPA**[®]
www.lampa.it



CATENE DA NEVE
E DISPOSITIVI PER LA TRAZIONE INVERNALE

SNOW CHAINS
AND WINTER TRACTION DEVICES

2016
2017

AutoSock[®]

SnowGecko

WINTER EXTREME



SnowDrive[®] TRACTION DEVICES

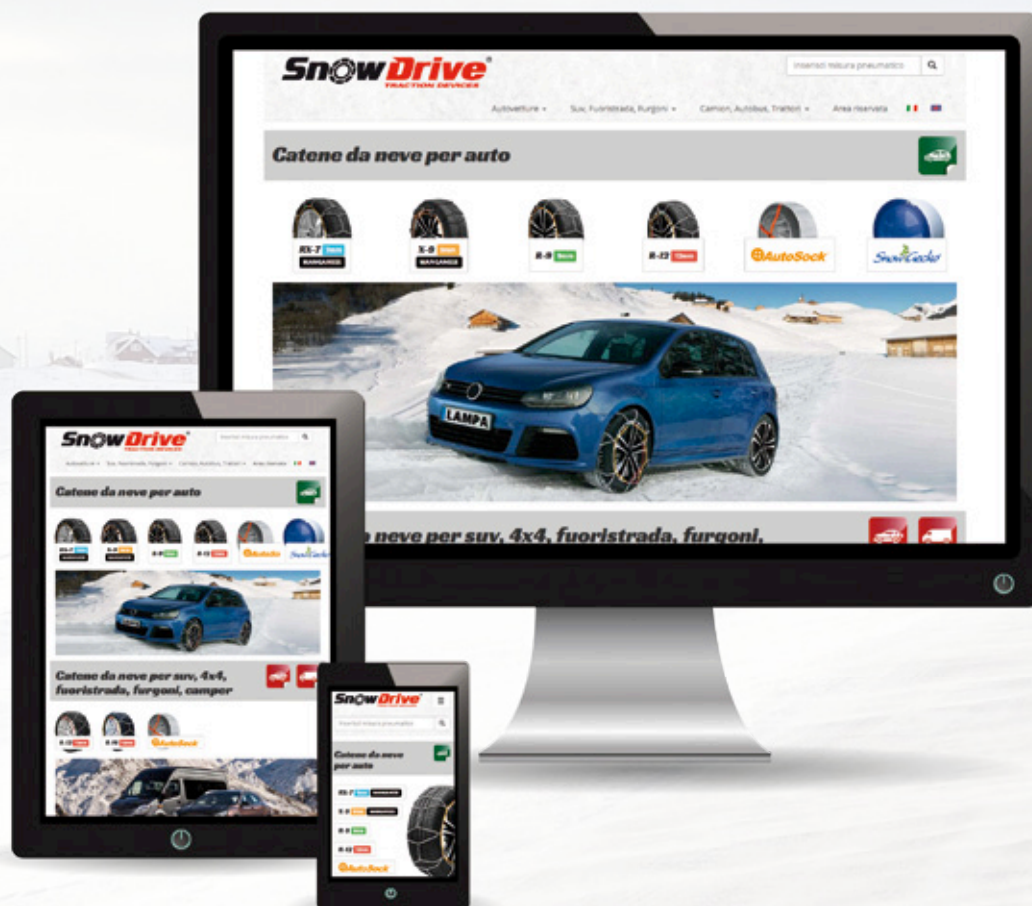

www.snowdrive.it

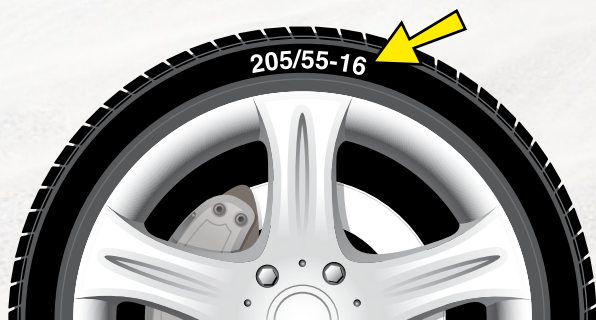

con guida alla scelta del dispositivo

Individuare le tre misure del pneumatico:

indica la larghezza

indica la spalla in percentuale

indica il diametro del cerchio in pollici

205/55-16

SnowDrive
TRACTION DEVICES



RX-7
(p. 4)



R-9
(p. 5)



X-9
(p. 6)



R-12
(p. 7)

WINTER EXTREME

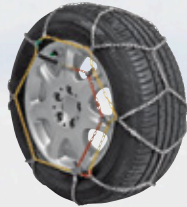

WX-9
(p. 25)

AutoSock

SnowGecko



AutoSock
(p. 29)



SnowGecko
(p. 32)

SnowDrive
TRACTION DEVICES



S-12
(p. 10)



S-16
(p. 11)

AutoSock



AutoSock
(p. 29)

SnowDrive
TRACTION DEVICES



Cargo-Plus
(p. 14)



Truck-Flex
(p. 15)



Cingoli Standard
(p. 18)



Cingoli Europa
(p. 20)



Cingoli Europa-Pro
(p. 21)

SnowDrive
TRACTION DEVICES



Pro Traction Plus
(p. 23)

AutoSock



AutoSock
(p. 34)



Catene da neve

Catene da neve costruite a regola d'arte e certificate, in ottemperanza al decreto 10 Maggio 2011, (Ministero delle infrastrutture e dei Trasporti, Gazzetta Ufficiale N. 185 del 10 Agosto 2011).

Dispositivi di aderenza supplementare omologati secondo le norme **ÖNORM V5117 / V5119**

L'acciaio, gli spessori, la cementazione e tutti i processi produttivi sono garantiti da sistemi aziendali con processi di gestione e controllo qualità certificati ISO 9001 da oltre 10 anni.

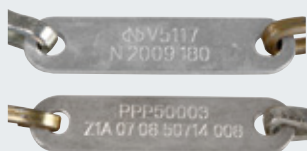

Numero di omologazione stampigliato sulla piastrina, facilmente ispezionabile e leggibile dalle autorità anche con catena montata



In Europa non esiste una normativa unica che regola l'utilizzo delle catene da neve, infatti ogni singolo stato ha una propria legislazione in materia. Pertanto negli stati europei si possono verificare le seguenti situazioni:

- obbligo di catene a bordo
- obbligo di catene a bordo per i residenti, nessun obbligo di catene a bordo per i turisti
- nessun obbligo di catene a bordo

Si consiglia comunque, prima di iniziare un viaggio, di reperire le opportune informazioni sul paese di destinazione (e dei paesi di transito).

In ogni caso, per fugare ogni dubbio, per la propria sicurezza e per quella degli altri, tenere sempre le catene a bordo nei periodi invernali.

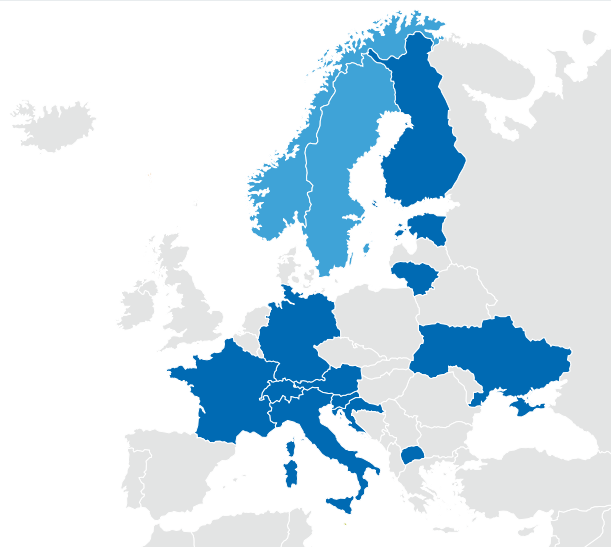

	CATENE DA NEVE					
	RX-7	X-9	R-9	R-12	S-16	S-12
Facilità di montaggio	**	***	**	**	**	**
Ingombro interno massimo	7 mm	9 mm	9 mm	12 mm	16 mm	12 mm
Compatibile ABS-ESP	●	●	●	●	●	●
Blocca-catenino in plastica composita	●	●	●	●	-	●
Cavo interno flessibile	●	●	●	●	●	●
Auto-Tensionamento	●	●	●	●	●	●
Materiale Battistrada	Acciaio al manganese	Acciaio al manganese	Acciaio cementato	Acciaio cementato	Acciaio cementato	Acciaio cementato
Battistrada	Rombo	Rombo	Rombo	Rombo	Rombo	Rombo + rinforzo
Sezione filo catena	3 mm	3 x 2,5 mm	3 x 2,5 mm	3,5 x 3,5 mm	4,3 x 4,3 mm	3,5 x 3,5 mm
Omologato per obbligo "catene a bordo"	●	●	●	●	●	●



Tabella applicazione su 2 lati
Fitting guide on both sides

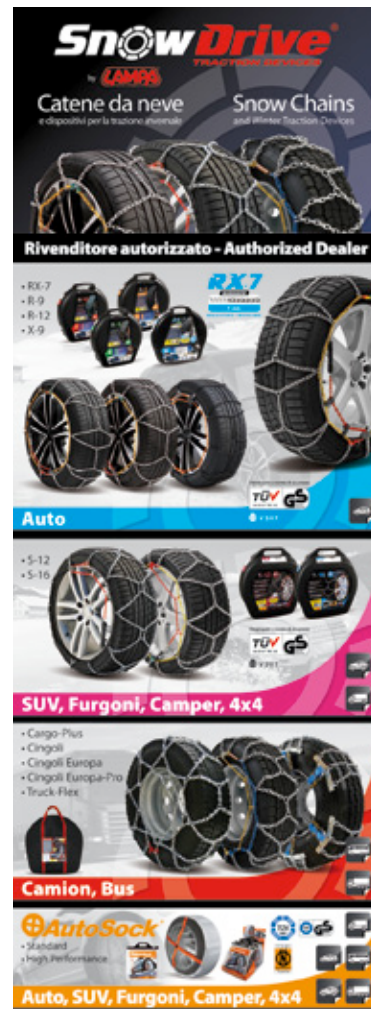

99199

POSTER CATENE CON TELAIO
SNOW CHAINS POSTER WITH STAND
cm 58x160

99076

ESPOSITORE CATENE (FORNITO SMONTATO)
Per 44 valigette auto o 40 valigette furgone
DISPLAY RACK
Holds 44 boxes (car-chains) or 40 boxes (van-chains)

Cartone / Carton 1



**CATENE DA NEVE A MAGLIA SPECIALE,
7 MM DI INGOMBRO INTERNO**
ideale per tutte le vetture con problema di
catenabilità

ACCIAIO AL MANGANESE
Per una maggiore resistenza all'usura

SNOW CHAINS WITH SPECIAL TWISTED LINKS
7 mm ultra-slim fit.

Special series for vehicles with chain restrictions

MANGANESE STEEL
for extra wear and tear resistance

Valigetta / Case 3

RX-7

MANGANESE



MAGLIA RITORTA - TWISTED LINKS

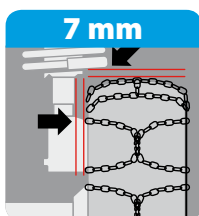

MONTAGGIO FACILE E VELOCE
QUICK AND EASY FITTING

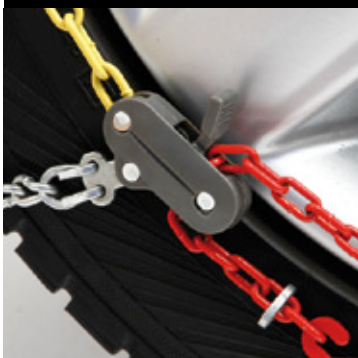

SISTEMA DI AUTO-TENSIONAMENTO

- Dopo il montaggio ed il tensionamento manuale, la catena può tendersi ulteriormente in modo automatico evitando ulteriori fermate durante la guida.
- Battistrada in acciaio cementato speciale.
- Maglie ritorte ad alta resistenza.
- Cavo interno flessibile per un montaggio facile, senza sollevare la vettura.
- Cricchetto e ganci di rinvio in resina composita ideale per non graffiare i cerchi in lega.

SELF-TENSIONING SYSTEM

- After the installation and the first manual tensioning, the chains tighten automatically while driving. No more stops for tensioning.
- Hardened special alloy steel.
- Special high resistance twisted-links.
- Flexible internal cable for an easy and quick-fit installation, without moving the vehicle.
- New composite plastic tensioning ratchet, ideal for preventing scratches on alloy wheels.

**ACCIAIO AL
MANGANESE
MANGANESE
STEEL**

Omologate a norma di sicurezza



V 5117



**CATENE DA NEVE A MAGLIA COMPATTA,
9 MM DI INGOMBRO INTERNO**

Ideale per tutte le vetture con spazio limitato tra pneumatico e parti meccaniche

SNOW CHAINS, QUICK AND EASY FITTING

9 mm slim fit cable links, specific for cars with limited gap between tire and mechanical parts.

Valigetta / Case 3

R-9

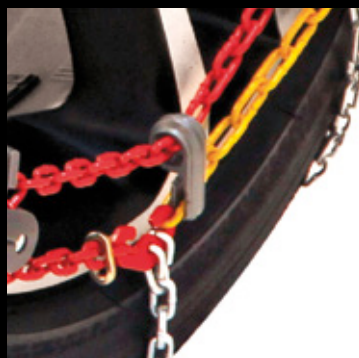
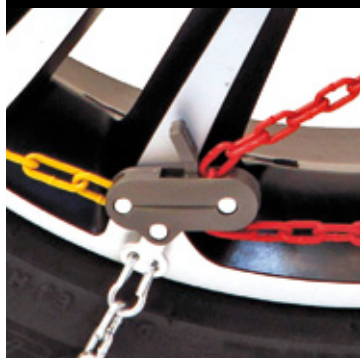
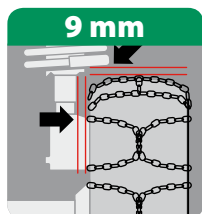

**MONTAGGIO
FACILE E VELOCE
QUICK AND EASY
FITTING**

Omologate a norma di sicurezza



V 5117

SISTEMA DI AUTO-TENSIONAMENTO

- Dopo il montaggio ed il tensionamento manuale, la catena può tendersi ulteriormente in modo automatico evitando ulteriori fermate durante la guida.
- Battistrada a rombo in acciaio cementato speciale.
- Maglie corte con sezione a "D" utilizzabili da entrambe le parti.
- Cavo interno flessibile per un montaggio facile senza sollevare e spostare la vettura.
- Nuovo blocca-catenino in plastica composita ideale per cerchi in lega.

SELF-TENSIONING SYSTEM

- After the installation and the first manual tensioning, the chains tighten automatically while driving. No more stops for tensioning.
- Hardened special alloy steel with diamond pattern grip.
- Flexible internal cable for an easy and quick installation without moving or lifting the car.
- New composite plastic ratchet, ideal for alloy rims



X-9 MANGANESE, 9 MM DI INGOMBRO INTERNO

Maglia compatta con sezione a "D" utilizzabili da entrambe le parti. Ideali per tutte le vetture con spazio limitato tra pneumatico e parti meccaniche.

ACCIAIO AL MANGANESE

Per una maggiore resistenza all'usura

X-9 MANGANESE, 9 MM SLIM FIT CABLE LINKS

Specific for cars with limited gap between tire and mechanical parts

Valigetta / Case 3

X-9
Black Power
MANGANESE

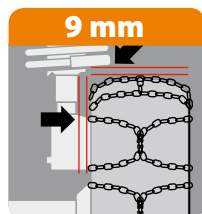

NUOVO SISTEMA CON SMONTAGGIO AUTOMATICO
AUTOMATIC RELEASE FUNCTION

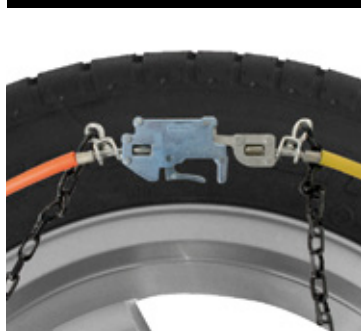

ACCIAIO AL MANGANESE
MANGANESE
STEEL



SISTEMA DI AUTO-TENSIONAMENTO

Dopo il montaggio ed il tensionamento manuale, la catena può tendersi ulteriormente in modo automatico evitando ulteriori fermate durante la guida.

NUOVO SISTEMA CON SMONTAGGIO AUTOMATICO

SELF-TENSIONING SYSTEM

After the installation and the first manual tensioning, the chains tighten automatically while driving. No more stops for tensioning.

AUTOMATIC RELEASE FUNCTION

New trigger mechanism for a quick and easy release

Omologate a norma di sicurezza



V 5117



**CATENE DA NEVE A MAGLIA STANDARD,
12 MM DI INGOMBRO INTERNO**

Sezione standard, alta resistenza, consigliata per tutte le vetture senza particolari limitazioni di ingombro tra pneumatico e parti meccaniche.

SNOW CHAINS, 12 MM EXTRA-STRONG LINKS

Specific for cars with standard gap between tire and mechanical parts.

Valigetta / Case 3



R-12

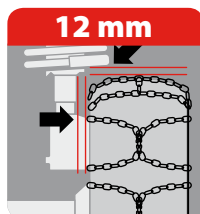

**MONTAGGIO
FACILE E VELOCE
QUICK AND EASY
FITTING**

Omologate a norma di sicurezza



V 5117

SISTEMA DI AUTO-TENSIONAMENTO

- Dopo il montaggio ed il tensionamento manuale, la catena può tendersi ulteriormente in modo automatico evitando ulteriori fermate durante la guida.
- Battistrada a rombo in acciaio cementato speciale.
- Maglie corte con sezione a "D" utilizzabili da entrambe le parti.
- Cavo interno flessibile per un montaggio facile senza sollevare e spostare la vettura.
- Nuovo blocca-catenino in plastica composita ideale per cerchi in lega.

SELF-TENSIONING SYSTEM

- After the installation and the first manual tensioning, the chains tighten automatically while driving. No more stops for tensioning.
- Hardened special alloy steel with diamond pattern grip.
- Flexible internal cable for an easy and quick installation without moving or lifting the car.
- New composite plastic ratchet, ideal for alloy rims



Tabella applicativa • Fitting guide

GR.	10"	12"	13"	14"	15"	16"	17"	18"	19"	20"	COD. ART.									
											RX-7	R-9	X-9	R-12						
1	120/80-10	120/80-12	125-13																	
	145/80-10	125/80-12	135/70-13																	
	145-10	125-12	145/60-13																	
	155/80-10	130/80-12																		
	155-10	135/80-12																		
	165/70-10	135-12																		
	500-10	140/70-12																		
	145/70-12																			
	150/65-12																			
	400-12																			
2		140-12	135/80-13																	
		145/80-12	135-13																	
		145-12	145/65-13																	
		150-12	145/70-13																	
		155/70-12	155/60-13																	
		165/60-12	155/65-13																	
		500-12	165/55-13																	
			165/60-13																	
			175/50-13																	
3		155/80-12	145/80-13	135/80-14	135/70-15															
		155-12	145-13	135-14	165/50-15															
		165/70-12	155/70-13	145/70-14																
		175/70-12	165/65-13	155/60-14																
		560-12	175/60-13	155/65-14																
		600-12	185/55-13	165/55-14																
				165/60-14																
			175/50-14																	
4			155/80-13	145/80-14	125-15															
			155-13	145-14	135-15															
			165/70-13	155/70-14	145/65-15															
			175/65-13	165/65-14	165/55-15															
			185/60-13																	
		195/55-13																		
4.5				175/60-14	155/65-15															
				185/55-14	175/50-15															
				185/50-15																
5			165/80-13	155/80-14	145-15															
			165-13	155-14	155/70-15															
			170-13	165/70-14	165/60-15															
			175/70-13	175/65-14	165/65-15															
			185/65-13	185/60-14	170/60-15															
			195/60-13	195/55-14	175/55-15															
			560-13	520-14	195/45-15															
			590-13	560-14																
6			175/75-13	165/75-14	155-15	165/55-16														
			175/80-13	165/80-14	165/70-15	175/55-16														
			175-13	165-14	175/60-15	185/50-16														
			185/70-13	175/70-14	175/65-15	195/45-16														
			195/65-13	185/65-14	185/55-15	205/40-16														
			205/60-13	195/60-14	195/50-15															
			640-13		560-15															
6.5				175/75-14	185/60-15	175/50-16														
				185/70-14	195/55-15	175/60-16														
				205/55-14	205/50-15	185/55-16														
						Pirelli Winter Snowcontrol 205/45-16 215/40-16														
7			195/70-13	175/80-14	175/70-15	195/50-16	205/40-17													
			600-13	175-14	185/65-15															
				195/65-14	195/60-15															
				205/60-14																
7.5					205/55-15	185/55-16	225/35-17													
					215/50-15	No Pirelli Winter Snowcontrol 185/60-16 205/50-16 215/45-16														



Tabella applicativa • Fitting guide

GR.	10"	12"	13"	14"	15"	16"	17"	18"	19"	20"	COD. ART.			
											RX-7	R-9	X-9	R-12
8			205/70-13	185/80-14 185-14 195/70-14 205/65-14 225/55-14	185/70-15 195/65-15 205/60-15	195/55-16 195/60-16	205/45-17 215/40-17				16387	16072	16412	16028
	8.5			225/60-14	225/50-15	225/45-16		205/40-18			16388	16073	16413	
		9			195/80-14 195-14 205/70-14 600-14	180-15 185-15 195/70-15 205/65-15 215/60-15 225/55-15	195/65-16 205/55-16 215/50-16	205/50-17 215/45-17 235/40-17	225/35-18		16389	16074	16414	16029
			9.5			235/60-14	195/75-15 205/70-15 215/65-15 225/60-15 235/55-15	205/60-16 215/55-16 225/50-16	215/50-17 No Keber Krisalp 225/45-17	215/40-18		16390	16075	16415
9.7						195/70-16 205/65-16 215/60-16 No Continental Premium Contact 2 No Michelin Primacy Energy Saver No Bridgestone Duravis Rxxx	205/55-17 245/40-17	215/45-18 225/40-18 245/35-18		16391	16081	16421		
	10				205/80-14 205-14 215/70-14 215-14	195/80-15 195-15 215/70-15 225/65-15 235/60-15 600-15 890-15	215/60-16 Continental Premium Contact 2 Michelin Primacy Energy Saver Bridgestone Duravis Rxxx	215/50-17 Keber Krisalp 215/55-17 225/50-17 235/45-17	225/45-18 235/40-18	235/35-19	16392	16076	16416	16030
12						215/65-16 225/60-16	235/50-17 245/45-17 255/40-17 265/40-17	215/50-18 235/45-18 245/40-18 255/35-18	225/40-19 235/40-19 245/35-19 255/30-19	16393	16078	16418	16039	
		12.5						215/60-17 225/55-17	215/55-18 275/35-18	245/40-19	16394	16082	16422	
			13				235/70-15	235/60-16 245/55-16	215/65-17 225/60-17 235/55-17 255/45-17 275/40-17	225/50-18 225/55-18 245/45-18 255/40-18 255/35-18 275/30-18 295/30-18	225/45-19 235/45-19 255/35-19 265/35-19	245/35-20 265/30-20	16395	16079
14						225/70-16 235/70-16	225/65-17 235/60-17 245/55-17	225/60-18 235/55-18 245/50-18	225/55-19 245/45-19	245/40-20 265/35-20 285/30-20	16080	16420		

Catena composta da 6 croci - Chain equipped with 6 crosses

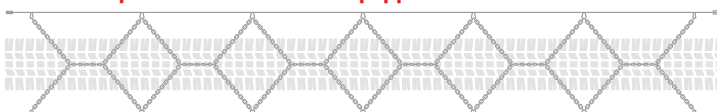

R-12

Tutti i gruppi
All groups

RX-7 **R-9** **X-9**

Gr. 1 - 2 - 3 - 4 - 4.5 - 5 - 6 - 7 - 7.5

Catena composta da 8 croci - Chain equipped with 8 crosses

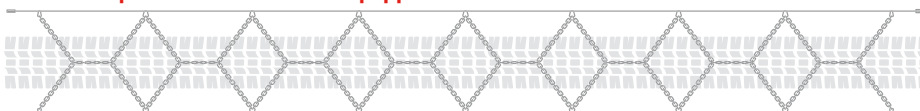

RX-7 **R-9** **X-9**

Gr. 8 - 8.5 - 9 - 9.5 - 9.7 - 10 - 12 - 12.5 - 13 - 14



**COPPIA CATENE DA NEVE
PER SUV, 4X4, FUORISTRADA**

12 mm di ingombro, per veicoli con spazio ridotto tra passaruota, organi di trasmissione, sospensioni, sistemi frenanti e pneumatico.

**PAIR OF SNOW CHAINS FOR SUV, 4X4,
AND OFF-ROAD VEHICLES**

12 mm width, suitable for vehicles with reduced space between mudguard, transmission system, suspensions, brake system and tire.

Valigetta / Case 1

S-12



**Blocca-catenino in
plastica composita
New composite
plastic ratchet**



**Doppio rinforzo
centrale
Double central
reinforcement**

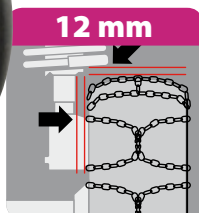

**MONTAGGIO FACILE E VELOCE
QUICK AND EASY FITTING**



**QUALITÀ GARANTITA, OMOLOGATE
DAL TÜV AUSTRIA E Ö-NORM AUSTRIACO**

- 12 mm di ingombro interno.
- Doppio rinforzo centrale per una miglior aderenza.
- Sistema di auto-tensionamento.
- Maglie esterne di regolazione.
- Battistrada a rombo in acciaio cementato.
- Maglie corte con sezione a "D" utilizzabili da entrambe le parti.
- Cavo interno flessibile per un montaggio facile.
- Blocca-catenino in plastica composita ideale per cerchi in lega.
- Guanti di protezione e maglie di riparazione in dotazione.

TÜV AUSTRIA AND Ö-NORM APPROVED QUALITY

- 12 mm slim-fit cable links.
- New self-tensioning system.
- External links for extra adjustments.
- Hardened special alloy steel with diamond pattern grip.
- Short D-section links usable on both sides.
- Flexible internal cable for an easy and quick installation.
- New composite plastic ratchet, ideal for alloy rims.
- Protection gloves and spare links included.

Omologate
a norma di
sicurezza



Ø V 5117



COPPIA CATENE DA NEVE PER FURGONI, SUV, FUORISTRADA, CAMPER

Con filo maggiorato da 4,3 mm per pneumatici uso pesante.

PAIR OF SNOW CHAINS FOR SUV, VANS AND OFFROAD

Chains with 4,3 mm wire for heavy duty tires.

Valigetta / Case 1

S-16



2
pcs

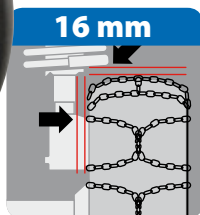

**MONTAGGIO FACILE E VELOCE
QUICK AND EASY FITTING**



**QUALITÀ GARANTITA, OMOLOGATE
DAL TÜV AUSTRIA E Ö-NORM AUSTRIACO**

- 16 mm di ingombro interno.
- Montaggio facile e rapido senza muovere il veicolo.
- Maglie compatte con sezione a "D".
- Catena laterale zincata e plastificata.
- Cavo interno flessibile plastificato con aggancio rapido.
- Aggancio esterno con blocca-catenino.
- Tirante con tensionamento automatico.
- Guanti di protezione e maglie di riparazione in dotazione.

**TÜV AUSTRIA AND Ö-NORM
APPROVED QUALITY**

- 16 mm chain width.
- Quick and easy installation without moving the car.
- "D" section compact links.
- Zincated and plastic-coated side chain.
- Plasticized flexible internal wire with quick-fitting.
- External fitting with chain-block.
- Self-tensioning ratchet.
- Protection gloves and spare links included.

Omologate
a norma di
sicurezza



V 5117



Tabella applicativa • Fitting guide

GR.	12"	13"	14"	15" 15.3"	16" 16.5"	17" 17.5"	18"	19" 19.5"	20"	21"	COD. ART.		
											S-12	S-16	
19			165/75-14 165/80-14 165-14 175/75-14 185/65-14									16101	
20			175/80-14 175-14 185/70-14 650-14									16102	
20.5	24x8.5-12	6.70-13	24x8.5-14									16116	
21			185/75-14 185/80-14 185-14 195/70-14 200-14 205/65-14 215/65-14 700-14	165-15 175/80-15 195/65-15 640-15							16460	16103	
22			195/75-14 195/80-14 195-14 205/70-14 215/70-14 25x8.5-14 670-14	185/80-15 185-15 195/70-15 205/65-15	175/75-16 175/80-16 175-16 195/65-16 200/70-16						16461	16104	
22.5			205/75-14 205/80-14 205-14	195/75-15 195/80-15 195-15 205/70-15 205/75-15 215/65-15	185/75-16 195/70-16 195/75-16 Kleber TransPro / Michelin Agilis Alpin Continental Vanco2 205/65-16 215/60-16 No Continental Premium Contact 2 No Michelin Primacy Energy Saver No Bridgestone Duravis Rxxx						16462	16105	
22.7				215/70-15	195/75-16 No Kleber TransPro / No Michelin Agilis Alpin / No Continental Vanco2 215/60-16 Continental Premium Contact 2 / Michelin Primacy Energy Saver / Bridgestone Duravis Rxxx	215/55-17 225/50-17						16463	16128
23			215/75-14 215/80-14 215-14 750-14	205/80-15 215/75-15 225/70-15 670-15	185/80-16 185-16 195/80-16 195-16 215/65-16 225/60-16 600-16 640-16	225/55-17		225/40-19				16464	16106
23.5					205/75-16 215/70-16 225/65-16 235/60-16	205/65-17 215/60-17 215/65-17	215/55-18 245/45-18	225/45-19				16465	16127
24				215/80-15 215-15 225/75-15 235/70-15 255/60-15 700-15	205/80-16 205-16 215/75-16 225/70-16 235/65-16 Goodyear Cargo Ultra Grip 2 255/40-16 650-16	225/60-17 235/55-17 205/65-17.5 7.0-17.5	225/55-18 235/50-18 255/45-18	235/45-19 255/40-19			16466	16107	
24.5				235/75-15 28x9-15	215/80-16 215/85-16 215-16 225/75-16 235/65-16 No Goodyear Cargo Ultra Grip 2 650-16.5	225/65-17 235/60-17 650-17	225/60-18 235/55-18 245/50-18	245/45-19 255/45-19	245/40-20			16467	16108



Tabella applicativa • Fitting guide

GR.	12"	13"	14"	15" 15.3"	16" 16.5"	17" 17.5"	18"	19" 19.5"	20"	21"	COD. ART.	
											S-12	S-16
24.6	27x8.5-12			27x8.5-15 8.15-15 S.E.								16117
24.7				255/70-15 30x9.50-15 8.40-15	235/70-16 255/65-16	225/70-17 235/65-17 255/55-17 205/75-17.5	235/60-18	225/55-19 235/50-19 275/40-19	235/45-20 255/40-20 275/35-20		16468	16110
24.8				250/70-15 250-15 700-15								16118
25				265/70-15 750-15 9.0-15	235/75-16 235/80-16 245/70-16 255/65-16 700-16 9.0x75-16	235/70-17 245/65-17 215/75-17.5 8-17.5	225/65-18 245/60-18	235/55-19 245/50-19	245/45-20		16469	16109
25.5				10.0-15 255/75-15 265/75-15 31x10.5-15	245/75-16 255/70-16	245/70-17 255/60-17 255/65-17 275/55-17	235/65-18 255/55-18 285/50-18	245/55-19 255/50-19 275/45-19	235/55-20 245/50-20 255/45-20 275/40-20		16470	16111
25.8	10x80-12			270/75-15 Nokian TRI-2 10.0x75-15.3	250/75-16 Nokian TRI-2 250/80-16 No Nokian TRI-2 260/70-16 10.0-16.5							16119
26					750-16 9.5-16.5	225/75-17.5 8.5-17.5		7.0-19.5				16112
26.3				29x12.5-15 29x12-15	315/55-16							16120
26.4				29x13.5-15								16121
26.5				31x11.5-15	235/85-16 265/70-16 280/70-16	265/65-17 275/60-17	255/60-18 265/60-18	255/55-19 265/50-19 285/45-19	255/50-20 265/45-20 275/45-20 295/40-20 315/35-20	265/40-21 265/45-21 295/35-21	16471	16113
26.7				32x11.5-15	265/75-16 275/70-16	245/75-17 265/70-17 275/65-17	265/65-18 275/60-18 285/55-18	265/55-19	265/50-20		16472	16122
26.8				31x15.5-15								16123
27				825-15	250/80-16 Nokian TRI-2 825-16	9.5-17 235/75-17.5 245/70-17.5 245/75-17.5 9.5-17.5	750-18	8-19.5	650-20 700-20		16473	16114
27.3					250/80-16							16124
27.4						285/70-17 10.0-17.5 265/70-17.5	250/80-18 275/65-18 285/65-18	245/70-19.5	275/55-20			16125
27.5					295/75-16			265/70-19.5	260/70-20			16115
27.7							10.5-18 10.5x80-18 275/80-18		280/70-20 9.5-20			16126



**CATENE DA NEVE
PER VEICOLI INDUSTRIALI**
Battistrada a rombo in acciaio speciale zincato con
aggiunta di maglie di rinforzo

**SNOW CHAINS FOR
HEAVY DUTY TRUCKS**
"D" shape chain and cross links reinforced. Anti
wear treatment, zinc galvanizing

Sacco / Sack 1

Cargo Plus Professional



Maglie di rinforzo
Cross link reinforced

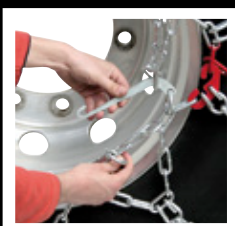

Omologate
a norma di
sicurezza



Ø V 5119 geprüft



CATENE DA NEVE PER CAMION E AUTOBUS

Montaggio e auto-tensionamento rapido
Con molla di tensione in acciaio
Battistrada a rombo in acciaio speciale
Utilizzabile da entrambe le parti per una durata maggiore

SNOW CHAINS FOR TRUCKS AND BUSES

Quick-mount, with self-tensioning system
Supplied with tensioning metal spring
Diamond-pattern grip made of special steel
May be used on both sides for an extended lifetime

Borsa in nylon / Nylon zip bag 1



Truck Flex

2
pcs



**MONTAGGIO FACILE E VELOCE
QUICK AND EASY FITTING**



Omologate
a norma di
sicurezza



Ø V 5119 geprüft



Tabella applicativa • Fitting guide

GR.	15" 15.3"	16" 16.5"	17"	17.5"	18"	19.5"	20"	22"	22.5"	24"	24.5"	CARGO PLUS	TRUCK FLEX
26		750-16 9.5-16.5		225/75-17.5 8.5-17.5		7.0-19.5						16154	16440
27	825-15	250/80-16 Nokian TRI-2 825-16	9.5-17	235/75-17.5 245/70-17.5 245/75-17.5 9.5-17.5	750-18	8-19.5	650-20 700-20					16160	
29							260/80-20 825-20		255/70-22.5 9.0-22.5 9.5-22.5	8.3-24		16165	
29.5		11.00-16 12.4-16				305/70-19.5			285/60-22.5 295/60-22.5			16166	
29.6	315/75-15 33x12.5-15 11.5x80-15.3 300/80-15.3	285/75-16 315/75-16 320/65-16 33x12.5-16 35x11.5-16	33x12.5-17		300/50-18 300/65-18 33x12.0-18							16167	
30		13.6-16					900-20		10.0-22.5 11x70-22.5 275/70-22.5 295/70-22.5 305/60-22.5	9.5-24		16168	
30.5									315/60-22.5			16169	
31	8.3-28	8.3-28					10.0-20 12x80-20		11.0-22.5 275/80-22.5 305/70-22.5 315/70-22.5 No Michelin XDN2 Grip No Michelin Multiway 3D XDE No Bridgestone M729	300/70-24		16170	16441
32							11.0-20		12.0-22.5 Michelin XDE 2+ / XZY 2 315/80-22.5 No Michelin XDN2 Grip		305/75-24.5	16171	16442
33							12.0-20	11.0-22	13.0-22.5 315/80-22.5 Michelin XDN2 Grip	10.0-24	315/75-24.5	16172	16443
35	35x12.5-15	12.0-16 255/100-16 315/80-16 35x12.5-16 900-16	315/70-17 35x12.5-17			275/70-19.5 285/70-19.5	275/65-20		295/55-22.5			16173	16444



Tabella applicativa • Fitting guide

GR.	15" 15.3"	16" 16.5"	17"	17.5"	18"	19.5"	20"	22"	22.5"	24"	24.5"	CARGO PLUS	TRUCK FLEX
35.8					12.0-18 12.0x12.5-18 320/80-18		10.5-20 275/80-20 300/70-20					16174	
36	36x13.5-15				12.5-18 12.5x80-18 335/80-18 340/80-18 365/70-18		320/70-20 38x14.00-20					16175	
37			500/50-17		12.0-18	15-19.5 425/55-19.5	12.4-20 12.5-20 12.5x80-20 13x80-20 320/85-20 335/80-20 340/75-20 340/80-20 375/70-20		12.0-22.5 No Michelin XDE 2+ / XZY 2 13x75-22.5 295/80-22.5 No Michelin XDN2 Grip No Michelin XDW Ice Grip No Bridgestone M729 315/70-22.5 Michelin XDN2 Grip Michelin Multiway 3D XDE Bridgestone M729 315/75-22.5 400/55-22.5	11.2-24 280/85-24 300/80-24 Nokian TRI-2		16176	16445
38							13.0-20 14.75x80-20 365/85-20				360/80-24	16177	
52							14.5-20 14.9-20 14x80-20 355/80-20 360/80-20 365/80-20 375/75-20 380/75-20		15-22.5 No Michelin XF 385/65-22.5	320/70-24		16180	
53									18-22.5 445/65-22.5			16181	

Pezzi per confezione Pcs / pack

Gr.	Cargo-Plus	Truck-Flex
26	2	2
27	2	2
29	2	2
29.5	1	2
29.6	1	2
30	1	2
30.5	1	2
31	2	2
32	2	2
33	2	2
35	2	2
35.8	1	2
36	1	2
37	2	2
38	1	2
52	2	2
53	1	2

Sezione delle maglie (mm) Section of link (mm)

Gr.	Cargo-Plus	Truck-Flex
26	5,7	5,7
27	5,7	
29	6,5	
29.5	7,0	
29.6	6,5	
30	7,0	
30.5	7,0	
31	7,0	7,0
32	7,0	7,0
33	7,0	7,0
35	7,0	6,4
35.8	7,0	
36	7,0	
37	7,0	7,0
38	7,0	
52	7,0	
53	7,0	





**CATENE A SETTORI - CINGOLI
PER CAMION E AUTOBUS**

Acciaio speciale legato
Interamente zincata
Maglie con sezione a "D"

**TRACK SECTOR CHAINS
FOR TRUCKS AND BUSES**

Special linked steel
"D" section links
Fully galvanized

Sfuso / Bulk 6



Cingoli Standard

1 pc

**Quantità min
1 sacco (6 pz)**
Min. quantity
1 sack (6 pcs)



**XS-2
S-2**
Settore a
2 traversini
2 cross-chains

**M-3
L-3
XL-3**
Settore a
3 traversini
3 cross-chains

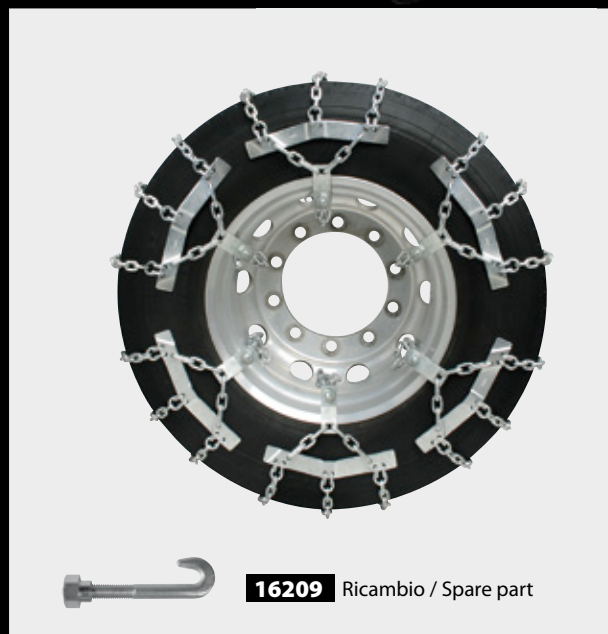
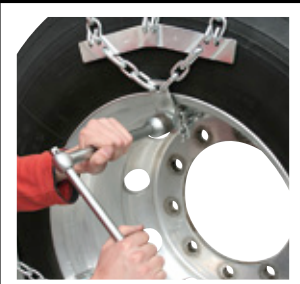

16209 Ricambio / Spare part



Tabella applicativa • Fitting guide

GR.	16"	17"	17.5"	18"	19"	19.5"	20"	22"	22.5"	24"	24.5"	CINGOLI STANDARD
XS-2	185/75-16 185/80-16 185-16 195/75-16 195/80-16 195-16 205/75-16 205/80-16 205-16 215/75-16 215/80-16 215/85-16 215-16 225/75-16 600-16 640-16 650-16		7.0-17.5			400-19						16201
S-2	700-16 750-16 825-16		205/75-17.5 215/75-17.5 225/75-17.5 235/75-17.5 245/70-17.5 245/75-17.5 8.5-17.5 8-17.5 9.5-17.5	700-18		7.0-19.5 8-19.5	650-20					16202
M-3		825-17				245/70-19.5 265/70-19.5 275/70-19.5 285/70-19.5 9.0-19.5 9.5-19.5	750-20 825-20 9.5-20		225/70-22.5 8-22.5 9.0-22.5			16203
L-3						305/70-19.5	900-20		10.0-22.5 275/70-22.5 295/60-22.5 295/70-22.5 305/60-22.5	9.5-24		16204
XL-3							1000-20 1100-20 12.5-20 1200-20 12x80-20 13x80-20 335/80-20	1100-22	11-22.5 12.0-22.5 12x80-22.5 13.0-22.5 275/80-22.5 295/80-22.5 305/70-22.5 315/60-22.5 315/70-22.5 315/75-22.5 315/80-22.5	11.2-24 300/80-24 Nokian TRI-2	305/75-24.5 315/75-24.5	16205



Sezione delle maglie

Gruppo	mm
XS-2	5,8
S-2	5,8
M-3	7
L-3	7
XL-3	7



**CATENE A SETTORI - CINGOLI
PER CAMION E AUTOBUS
SERIE EUROPA
CON NASTRO A MONTAGGIO RAPIDO**

Acciaio speciale legato
Interamente zincata.
Maglie con sezione a "D"

**TRACK SECTORS CHAINS
FOR TRUCK AND BUS,
EUROPE SERIES,
QUICK-FIT BELT SYSTEM**

Special linked steel
"D" section links. Fully galvanized

Sfuso / Bulk 6

Cingoli Europa

1 pc

**Quantità min
1 sacco (6 pz)**
Min. quantity
1 sack (6 pcs)

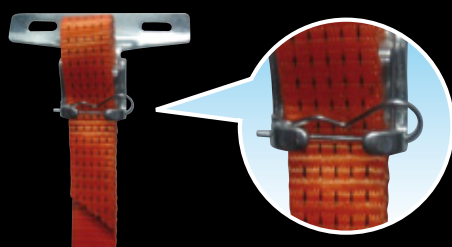



**CATENE A SETTORI - CINGOLI
PER CAMION E AUTOBUS
SERIE EUROPA-PRO
CON NASTRO E CRICCHETTO**

Acciaio speciale legato
Interamente zincata.
Maglie con sezione a "D" da 7 mm

**TRACK SECTORS CHAINS
FOR TRUCK AND BUS,
EUROPE-PRO SERIES,
BELT SYSTEM WITH RATCHET**

Special linked steel
7 mm "D" section links.
Fully galvanized

Sfuso / Bulk 3

Cingoli Europa-Pro

1 pc

Quantità min
1 sacco (3 pz)
Min. quantity
1 sack (3 pcs)





Tabella applicativa • Fitting guide

GR.	16"	17"	17.5"	18"	19"	19.5"	20"	22"	22.5"	24"	24.5"	EUROPA	EUROPA PRO
1E	185/75-16		205/75-17.5	700-18	400-19	7.0-19.5	650-20					16210	16217
	185/80-16		215/75-17.5			8-19.5							
	185-16		225/75-17.5										
	195/75-16		235/75-17.5										
	195/80-16		245/70-17.5										
	195-16		245/75-17.5										
	205/75-16		7.0-17.5										
	205/80-16		8.5-17.5										
	205-16		8-17.5										
	215/75-16		9.5-17.5										
	215/80-16												
	215/85-16												
	215-16												
	225/75-16												
	600-16												
	640-16												
	650-16												
700-16													
750-16													
825-16													
2E		825-17				245/70-19.5	1000-20	1100-22	11-22.5	11.2-24	305/75-24.5	16211	16215
						265/70-19.5	1100-20		12.0-22.5	300/80-24	315/75-24.5		
						275/70-19.5	12.5-20		12x80-22.5	Nokian TRI-2			
						285/70-19.5	1200-20		13.0-22.5				
						9.0-19.5	12x80-20		225/70-22.5				
						9.5-19.5	13x80-20		275/80-22.5				
							335/80-20		295/80-22.5				
							750-20		305/60-22.5				
							825-20		305/70-22.5				
							9.5-20		315/60-22.5				
3E						305/70-19.5	900-20		10-22.5	9.5-24		16216	
									275/70-22.5				
									295/60-22.5				
									295/70-22.5				
									305/60-22.5				

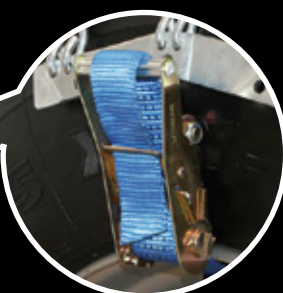
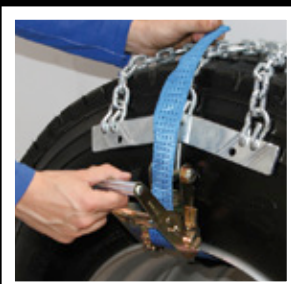
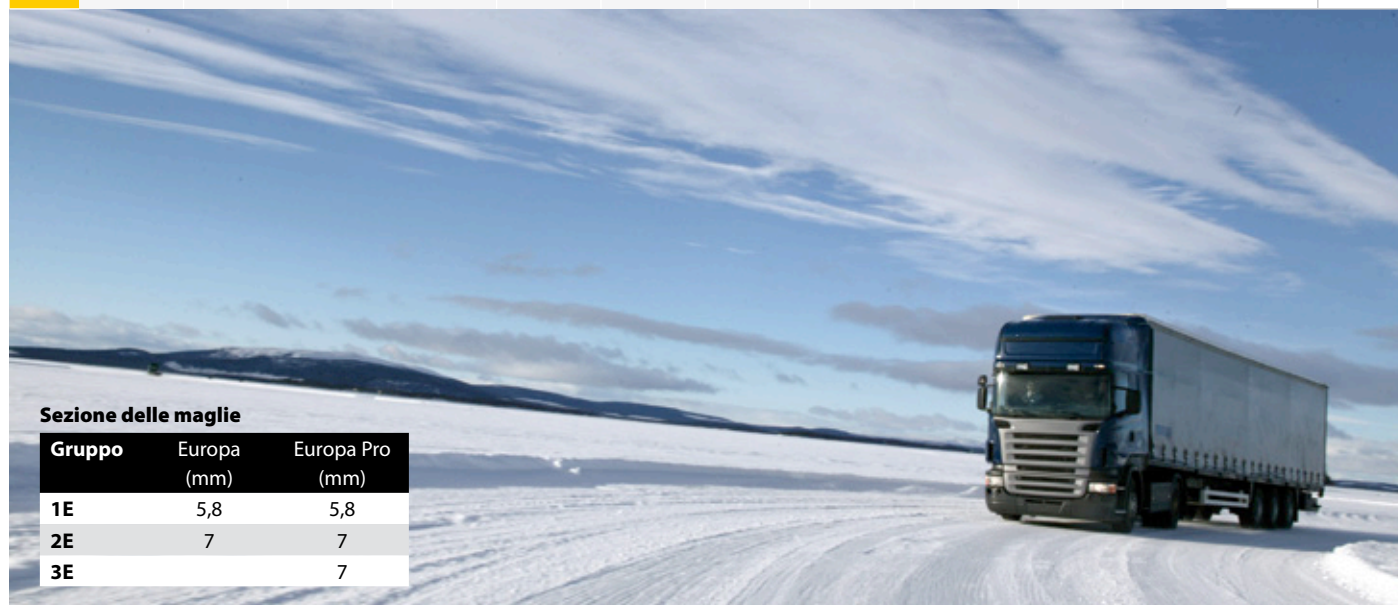

Sezione delle maglie

Gruppo	Europa (mm)	Europa Pro (mm)
1E	5,8	5,8
2E	7	7
3E	7	7



**CATENE DA NEVE PER TRATTORI,
MACCHINE OPERATRICI E VEICOLI SPECIALI**

- Battistrada a doppio rombo in acciaio speciale zincato con aggiunta di maglie di rinforzo e barrette anti-usura da 1 cm di spessore
- Maglie con sezione a D da 7, 8 e 10 mm
- Tensionamento manuale tramite catenino e leva
- Confezionate in casse di plastica

**SNOW CHAINS FOR SNOW REMOVERS,
TRACTORS AND SPECIAL VEHICLES**

- Double diamond pattern chain in galvanized steel with extra links and 1 cm thickness steel bars
- D-cross section of 7, 8 and 10 mm
- Hand tensioning by lateral chain and tightening lever
- Plastic crates



**BARRETTE ANTIUSURA DA 1 CM
1 CM THICKNESS STEEL BARS**

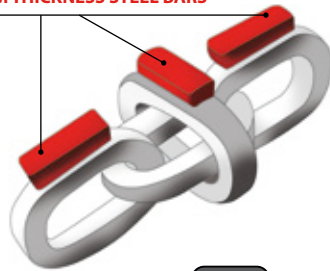

2
pcs

Pro Traction Plus

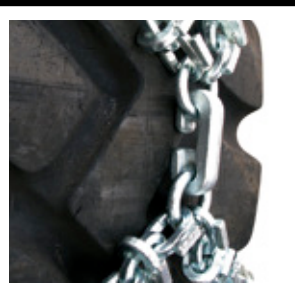
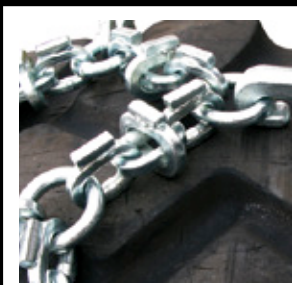



GR.	12"	15" 15.3"	16" 16.5"	17" 17.5"	18"	19.5"	20"	22"	22.5"	24"	24.5"	25"	PRO TRACTION PLUS
25.8	10x80-12	270/75-15 Nokian TRI-2 10.0x75-15.3	10x80-12 250/75-16 Nokian TRI-2 250/80-16 No Nokian TRI-2 260/70-16 10.0-16.5										16220
26			750-16 9.5-16.5	225/75-17.5 8.5-17.5		7.0-19.5							16221
32							11.0-20		12.0-22.5 Michelin XDE 2+ / XZY 2 315/80-22.5 No Michelin XDN2 Grip		305/75-24.5		16222
33							12.0-20	11.0-22	13.0-22.5 315/80-22.5 Michelin XDN2 Grip	10.0-24	315/75-24.5		16223
35.8					12.0-18 12.0x12.5-18 320/80-18		10.5-20 275/80-20 300/70-20						16224
36		36x13.5-15			12.5-18 12.5x80-18 335/80-18 340/80-18 365/70-18		320/70-20 38x14.00-20						16225
37				500/50-17	12.0-18	15-19.5 425/55-19.5	12.4-20 12.5-20 12.5x80-20 13x80-20 320/85-20 335/80-20 340/75-20 340/80-20 375/70-20		12.0-22.5 No Michelin XDE 2+ / XZY 2 13x75-22.5 295/80-22.5 No Michelin XDN2 Grip No Michelin XDW Ice Grip No Bridgestone M729 315/70-22.5 Michelin XDN2 Grip Michelin Multway 3D XDE Bridgestone M729 315/75-22.5 400/55-22.5	11.2-24 280/85-24 300/80-24 Nokian TRI-2			16226
37.3							360/70-20 41x14.00-20			360/60-24			16227
50.5					405/70-18		16/70-20 16-20 380/70-20 400/70-20 405/70-20 420/65-20		15-22.5 Michelin XF				16228
52							14.5-20 14.9-20 14x80-20 355/80-20 360/80-20 365/80-20 375/75-20 380/75-20		15-22.5 No Michelin XF 385/65-22.5	320/70-24			16229
58.0			17.5-25 445/80-25									17.5-25 445/80-25	16230
77.5										360/70-24			16231
78										13.6-24 340/85-24			16232

Sezione delle maglie

Gruppo	mm	Gruppo	mm
25.8	7	50.5	8
26	7	52	8
32	7	58.0	10
33	7	77.5	7
35.8	7	78	7
36	7		
37	7		
37.3	7		



WINTER EXTREME



CATENE DA NEVE A MAGLIA COMPATTA, 9 MM DI INGOMBRO INTERNO

Ideale per tutte le vetture con spazio limitato tra pneumatico e parti meccaniche

SNOW CHAINS, QUICK AND EASY FITTING

9 mm slim fit cable links, specific for cars with limited gap between tire and mechanical parts.

Valigetta / Case 4



WX-9

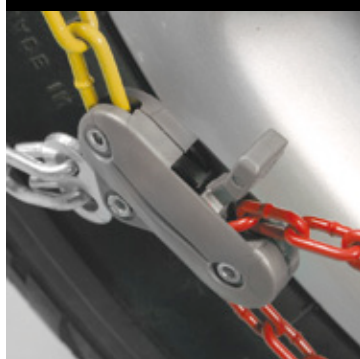
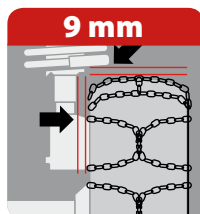

**MONTAGGIO
FACILE E VELOCE
QUICK AND EASY
FITTING**

Omologate a norma di sicurezza



V 5117

SISTEMA DI AUTO-TENSIONAMENTO

- Dopo il montaggio ed il tensionamento manuale, la catena può tendersi ulteriormente in modo automatico evitando ulteriori fermate durante la guida.
- Battistrada a rombo in acciaio cementato speciale.
- Maglie corte con sezione a "D" utilizzabili da entrambe le parti.
- Cavo interno flessibile per un montaggio facile senza sollevare e spostare la vettura.
- Nuovo blocca-catenino in plastica composita ideale per cerchi in lega.

SELF-TENSIONING SYSTEM

- After the installation and the first manual tensioning, the chains tighten automatically while driving. No more stops for tensioning.
- Hardened special alloy steel with diamond pattern grip.
- Flexible internal cable for an easy and quick installation without moving or lifting the car.
- New composite plastic ratchet, ideal for alloy rims



Tabella applicativa • Fitting guide

GR.	10"	12"	13"	14"	15"	16"	17"	18"	19"	20"	COD. ART.
											WX-9
1	120/80-10	120/80-12	125-13								GD02001
	145/80-10	125/80-12	135/70-13								
	145-10	125-12	145/60-13								
	155/80-10	130/80-12									
	155-10	135/80-12									
	165/70-10	135-12									
	500-10	140/70-12									
	145/70-12										
	150/65-12										
	400-12										
2		140-12	135/80-13								GD02002
		145/80-12	135-13								
		145-12	145/65-13								
		150-12	145/70-13								
		155/70-12	155/60-13								
		165/60-12	155/65-13								
		500-12	165/55-13								
			165/60-13								
		175/50-13									
3		155/80-12	145/80-13	135/80-14	135/70-15						GD02003
		155-12	145-13	135-14	165/50-15						
		165/70-12	155/70-13	145/70-14							
		175/70-12	165/65-13	155/60-14							
		560-12	175/60-13	155/65-14							
		600-12	185/55-13	165/55-14							
				165/60-14							
			175/50-14								
4			155/80-13	145/80-14	125-15						GD02005
			155-13	145-14	135-15						
			165/70-13	155/70-14	145/65-15						
			175/65-13	165/65-14	165/55-15						
			185/60-13								
			195/55-13								
4.5				175/60-14	155/65-15						GD02006
				185/55-14	175/50-15						
5			165/80-13	155/80-14	145-15						GD02007
			165-13	155-14	155/70-15						
			170-13	165/70-14	165/60-15						
			175/70-13	175/65-14	165/65-15						
			185/65-13	185/60-14	170/60-15						
			195/60-13	195/55-14	175/55-15						
			560-13	520-14	195/45-15						
		590-13	560-14								
6			175/75-13	165/75-14	155-15	165/55-16					GD02009
			175/80-13	165/80-14	165/70-15	175/55-16					
			175-13	165-14	175/60-15	185/50-16					
			185/70-13	175/70-14	175/65-15	195/45-16					
			195/65-13	185/65-14	185/55-15	205/40-16					
			205/60-13	195/60-14	195/50-15						
			640-13		560-15						
6.5				175/75-14	185/60-15	175/50-16					GD02010
				185/70-14	195/55-15	175/60-16					
				205/55-14	205/50-15	185/55-16					
						Pirelli Winter Snowcontrol					
						205/45-16					
					215/40-16						
7			195/70-13	175/80-14	175/70-15	195/50-16	205/40-17				GD02011
			600-13	175-14	185/65-15						
				195/65-14	195/60-15						
				205/60-14							
7.5					205/55-15	185/55-16	225/35-17				GD02012
					215/50-15	No Pirelli Winter Snowcontrol					
						185/60-16					
						205/50-16					
						215/45-16					



Tabella applicativa • Fitting guide

GR.	10"	12"	13"	14"	15"	16"	17"	18"	19"	20"	COD. ART.
											WX-9
8			205/70-13	185/80-14 185-14 195/70-14 205/65-14 225/55-14	185/70-15 195/65-15 205/60-15	195/55-16 195/60-16	205/45-17 215/40-17				GD02013
8.5				225/60-14	225/50-15	225/45-16		205/40-18			GD02014
9				195/80-14 195-14 205/70-14 600-14	180-15 185-15 195/70-15 205/65-15 215/60-15 225/55-15	195/65-16 205/55-16 215/50-16	205/50-17 215/45-17 235/40-17	225/35-18			GD02015
9.5				235/60-14	195/75-15 205/70-15 215/65-15 225/60-15 235/55-15	205/60-16 215/55-16 225/50-16	215/50-17 No Keber Krisalp 225/45-17	215/40-18			GD02016
9.7						195/70-16 205/65-16 215/60-16 No Continental Premium Contact 2 No Michelin Primacy Energy Saver No Bridgestone Duravis Rxxx	205/55-17 245/40-17	215/45-18 225/40-18 245/35-18			GD02017
10				205/80-14 205-14 215/70-14 215-14	195/80-15 195-15 215/70-15 225/65-15 235/60-15 600-15 890-15	215/60-16 Continental Premium Contact 2 Michelin Primacy Energy Saver Bridgestone Duravis Rxxx 225/55-16 235/50-16 245/45-16	215/50-17 Keber Krisalp 215/55-17 225/50-17 235/45-17	225/45-18 235/40-18	235/35-19		GD02018
12						215/65-16 225/60-16	235/50-17 245/45-17 255/40-17 265/40-17	215/50-18 235/45-18 245/40-18 255/35-18	225/40-19 235/40-19 245/35-19 255/30-19		GD02019
12.5							215/60-17 225/55-17	215/55-18 275/35-18	245/40-19		GD02020
13					235/70-15	235/60-16 245/55-16	215/65-17 225/60-17 235/55-17 255/45-17 275/40-17	225/50-18 225/55-18 245/45-18 255/40-18 255/45-18 295/30-18	225/45-19 235/45-19 255/35-19 265/35-19 275/30-19	245/35-20 265/30-20	GD02021
14						225/70-16 235/70-16	225/65-17 235/60-17 245/55-17	225/60-18 235/55-18 245/50-18	225/55-19 245/45-19	245/40-20 265/35-20 285/30-20	GD02022

Catena composta da 6 croci - Chain equipped with 6 crosses

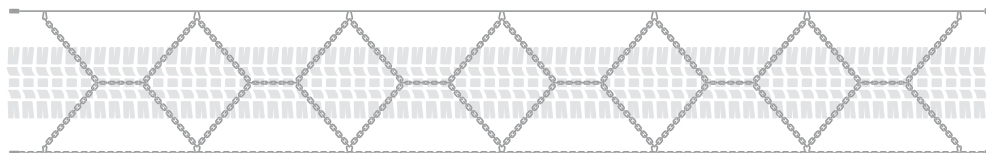

Tutti i gruppi
All groups



NUOVA CONFEZIONE
in valigetta di facile apertura e chiusura,
dotata di apertura intelligente per un facile
inserimento delle catene dopo l'utilizzo



Scatola chiusa con
sigillo di garanzia a conferma
che la confezione è integra
e non è mai stata aperta



Nuova grafica, con misura ripetuta su 3 lati, idonea per esposizione su scaffale con vista dal fronte oppure su espositore con vista laterale

FRONTE



LATO



RETRO



**SCAFFALE
CON VISTA FRONTALE**

**ESPOSITORE
CON VISTA LATERALE**





LA SOLUZIONE PER LA TRAZIONE INVERNALE







L'UNICA ORIGINALE E BREVETTATA

AutoSock® è protetto da brevetto Europeo No. 1.165.329
 The AutoSock® product is protected by European patent No. 1.165.329

AutoSock è un tipo di dispositivo antiscivolo che mira ad aumentare l'attrito delle ruote su strade innevate e con presenza di ghiaccio:

- **approvato dagli enti di certificazione TÜV SÜD, GS e Ö-NORM**
- **approvato ed omologato TÜV**
- **approvato dalle maggiori case automobilistiche**
- **facile e veloce da montare e rimuovere anche in condizioni meteo avverse.**
- leggero e facile da riporre.
- comodo durante la guida, non provoca vibrazioni o rumori
- si centra da solo
- riutilizzabile e lavabile in lavatrice
- riciclabile ed ecologico, non reca danni all'ambiente
- non danneggia i cerchi
- adatto a tutti i veicoli con poco spazio tra ruota, carrozzeria ed impianto frenante
- incrementa l'efficienza dei sistemi elettronici di sicurezza (ABS, ESP, ETS, ASR, DSC)



VELOCE, PRATICO E SOPRATTUTTO SICURO.

Le qualità di Autosock sono garantite oltre che dalle certificazioni anche da numerosi riconoscimenti e premi internazionali



IDEALE PER LE VETTURE MODERNE

AutoSock è adatto per tutti i veicoli con poco spazio tra la ruota, le parti meccaniche e la carrozzeria.



Nel gennaio 2008 Autosock è stato certificato dal TÜV Tedesco, il maggiore ed autorevole ente certificante europeo per i veicoli (divisione TÜV SÜD, responsabile per i test sulla trazione), secondo le normative:
ÖNorm V 5121: 2007
PPP 53219: 2000
DIN 31000: 1979

Autosock ha superato con successo i test della nuova normativa **ÖNORM V 5121**. E nella primavera 2008 è stato omologato. (Omologazione N° 2008 087)





GR.	MISURE PNEUMATICI / TIRE SIZES										STANDARD	
	12"	13"	14"	15"	16"	17"	18"	19"	20"	21"		
54	155/80-12 155-12	145/80-13										105401010
		155/70-13	155/65-14	155/60-15								
		155/80-13	165/55-14	165/50-15								
		165/65-13	165/60-14	165/55-15								
		165/70-13	165/65-14	165/60-15								
		175/65-13	175/60-14	185/50-15								
		185/60-13	185/55-14	195/45-15								
		195/55-13										
58		165/80-13 165-13	165/70-14	165/70-15							105801010	
		175/70-13	175/65-14	175/55-15								
		175/75-13	185/60-14	175/60-15	175/60-16							
		185/65-13	185/65-14	185/55-15	185/50-16							
		185/70-13	195/55-14	185/60-15	195/45-16							
		195/65-13	195/60-14	195/50-15	195/50-16							
		195/70-13	205/55-14	195/55-15								
			205/60-14									
62		175-13	185/70-14	185/65-15	185/55-16						106200810	
		205/70-13	195/65-14	195/60-15	195/55-16							
				205/55-15								



STANDARD

Adatta per la vettura con pneumatici di dimensioni normali

Busta / Bag 12

GR.	MISURE PNEUMATICI / TIRE SIZES										HIGH PERFORMANCE	
	12"	13"	14"	15"	16"	17"	18"	19"	20"	21"		
540	155/80-12 155-12	145/80-13										305401080
		155/70-13	155/65-14	155/60-15								
		155/80-13	165/55-14	165/50-15								
		165/65-13	165/60-14	165/55-15								
		165/70-13	165/65-14	165/60-15								
		175/65-13	175/60-14	185/50-15								
		185/60-13	185/55-14	195/45-15								
		195/55-13										
600		155-13	155-14	155/70-15	175/55-16						305800880	
		165/80-13	165/70-14	165/70-15	175/60-16							
		165-13	175/65-14	175/55-15	175/60-16	185/50-16						
		175/70-13	175/70-14	175/60-15	185/50-16	185/55-16						
		175/75-13	185/60-14	185/55-15	195/45-16	195/45-17						
		175-13	185/65-14	185/60-15	195/50-16	205/40-17						
		185/65-13	185/70-14	185/65-15	195/50-16	215/35-17						
		185/70-13	195/55-14	185/65-15	195/55-16	215/40-17						
		185/70-13	195/60-14	195/50-15	205/45-16							
		195/65-13	195/60-14	195/55-15	205/50-16							
		195/70-13	195/65-14	195/60-15	215/40-16							
		205/70-13	205/55-14	205/50-15	215/45-16							
			205/60-14	205/55-15								
605				205/50-15	205/45-16	205/40-17					305850080	
				215/40-16	215/35-17							
				215/45-16	215/40-17							
620		175-13	185/70-14	175/65-15	185/55-16						306250880	
		175-13	185/70-14	185/65-15	185/55-16							
		205/70-13	195/65-14	195/60-15	195/55-16							
		205/70-13	195/65-14	195/60-15	195/55-16							
				205/55-15	205/50-16							
				205/55-15								
625					205/50-16	195/45-17	235/35-18				306050080	
					205/50-16	215/45-17	235/40-17					
645			175/80-14	175/75-15	195/60-16	205/45-17	215/40-18				306250080	
			185/80-14	185/70-15	195/65-16	205/50-17	215/45-18					
			185-14	195/65-15	205/55-16	215/45-17	225/35-18					
			195/70-14	195/70-15	205/60-16	205/50-17	225/40-18	225/35-19				
			195/75-14	205/60-15	215/50-16	225/45-17	235/35-18	245/30-19				
			205/65-14	205/65-15	215/55-16	235/40-17	235/40-18					
			205/70-14	215/60-15	225/50-16	235/45-17	245/35-18					
						245/40-17						



HIGH PERFORMANCE

Adatta per le vetture equipaggiate con pneumatici a sezione larga e per SUV, 4x4, Furgoni, Camper...

Busta / Bag 12



GR.	MISURE PNEUMATICI / TIRE SIZES										HIGH PERFORMANCE	
	12"	13"	14"	15"	16"	17"	18"	19"	20"	21"		
665			215/70-14	215/65-15 225/60-15	195/65-16 205/60-16 215/60-16 225/55-16	205/55-17 215/50-17 225/50-17 245/45-17	215/45-18 225/45-18	225/40-19 235/35-19				306350080
685			195-14 215/70-14 215/75-14	195/75-15 195/80-15 205/70-15 215/65-15 215/70-15 225/60-15	185/75-16 205/65-16 215/60-16 215/65-16 225/55-16 225/60-16	215/55-17 225/50-17 225/55-17 235/50-17 245/45-17 255/40-17	225/45-18 225/50-18 235/45-18 245/40-18 255/35-18	225/40-19 235/35-19 245/35-19				306500080
695				205/75-15 215/75-15 225/70-15	195/75-16 205/75-16 215/70-16 225/65-16 235/60-16	205/65-17 215/60-17 225/60-17 235/55-17 245/50-17	215/55-18 225/55-18 235/50-18 245/45-18 255/40-18	235/45-19 245/40-19 245/45-19 255/40-19	245/35-20 245/40-20 255/35-20			306850080
697				215/80-15 225/75-15 235/75-15 245/75-15 255/70-15 265/70-15	215/75-16 215/80-16 225/70-16 225/75-16 235/65-16 235/70-16 235/75-16 245/70-16 255/65-16	225/65-17 225/70-17 235/60-17 235/65-17 245/65-17 255/60-17 265/55-17	225/60-18 235/55-18 235/60-18 245/55-18 245/60-18 255/55-18 265/55-18	225/55-19 235/55-19 255/50-19 265/50-19 275/45-19	245/45-20 245/50-20 255/45-20 265/45-20 275/40-20	265/40-21	307200980	
698				255/75-15 265/75-15	215/85-16 245/75-16 255/70-16 265/70-16	245/70-17 255/65-17 255/70-17 265/65-17 275/60-17	225/70-18 235/65-18 255/60-18 265/55-18 265/60-18	255/55-19 265/55-19	235/55-20 255/50-20 255/55-20 265/50-20	255/50-21	307600980	
699				245/85-15	235/85-16 265/75-16	245/75-17 265/70-17	265/65-18					307800980



HIGH PERFORMANCE

Adatta per le vetture equipaggiate con pneumatici a sezione larga e per SUV, 4x4, Furgoni, Camper...

Busta / Bag 12

99070

Espositore da banco 6 coppie

COPRE L'80% DELLA QUOTA DI MERCATO AUTO

Assortimento consigliato:

- 1 misura 58 / 600
- 3 misura 62 / 600
- 2 misura 645



Espositori forniti vuoti.
Prodotto da ordinarsi separatamente.



99071

Espositore per punto vendita 18 coppie

COPRE IL 100% DELLA QUOTA DI MERCATO (tutte le misure di pneumatici)

Assortimento consigliato:

- 1 misura 54 / 540
- 2 misura 58 / 600
- 2 misura 62 / 600
- 1 misura 605
- 1 misura 620 / 600
- 1 misura 625
- 3 misura 645
- 2 misura 665
- 1 misura 685
- 1 misura 695
- 1 misura 697
- 1 misura 698
- 1 misura 699



SnowGecko è un nuovissimo tipo di dispositivo antiscivolo che mira ad aumentare l'attrito delle ruote su strade innevate e con presenza di ghiaccio:

- **approvato dagli enti di certificazione TÜV SÜD, GS e Ö-NORM**
- **approvato ed omologato TÜV**
- **approvato dalle maggiori case automobilistiche**
- **facile e veloce da montare e rimuovere anche in condizioni meteo avverse.**
- leggero e facile da riporre.
- comodo durante la guida, non provoca vibrazioni o rumori
- si centra da solo
- riutilizzabile e lavabile in lavatrice
- riciclabile ed ecologico, non reca danni all'ambiente
- non danneggia i cerchi
- per i veicoli con poco spazio tra ruota, carrozzeria ed impianto frenante
- incrementa l'efficienza dei sistemi elettronici di sicurezza (ABS, ESP, ETS, ASR, DSC)

Serie COMPACT

Solo 4 misure per coprire il 90 % della quota di mercato pneumatici Auto

COMPACT Series

4 sizes only but sufficient to cover 90% of car tire sizes on the market



VELOCE, PRATICO E SOPRATTUTTO SICURO.

Le qualità di SnowGecko sono garantite oltre che dalle certificazioni anche da numerosi riconoscimenti e premi internazionali



IDEALE PER LE VETTURE MODERNE

SnowGecko è adatto per tutti i veicoli con poco spazio tra la ruota, le parti meccaniche e la carrozzeria.



L'UNICA ORIGINALE E BREVETTATA



Nel gennaio 2008 SnowGecko è stato certificato dal TÜV Tedesco, il maggiore ed autorevole ente certificante europeo per i veicoli (divisione TÜV SÜD, responsabile per i test sulla trazione), secondo le normative: **ÖNorm V 5121: 2007**
PPP 53219: 2000
DIN 31000: 1979

SnowGecko ha superato con successo i test della nuova normativa **ÖNorm V 5121**. E nella primavera 2008 è stato omologato. (Omologazione N° 2008 088)





GR.	MISURE PNEUMATICI / Tire SIZES					SNOWGECKO
	13"	14"	15"	16"	17"	
S	145/80-13 155/70-13 165/65-13 165/70-13 175/65-13	145/70-14 155/65-14 155/70-14 165/55-14 165/60-14 175/60-14				205400201
M	115/80-13 155-13 165-13 165/80-13 175/70-13 175/75-13 185/65-13 185/70-13 195/65-13 195/70-13	145-14 155-14 165/65-14 165/70-14 175/65-14 175/70-14 185/60-14 185/65-14 195/55-14 195/60-14 205/55-14 205/60-14	155/65-15 155/70-15 165/65-15 175/65-14 175/55-15 175/60-15 185/55-15 185/60-15 195/55-15	165/55-16 185/50-16 195/45-16 195/50-16 205/40-16		205701601
L	175-13 205/70-13	165-14 175-14 175/80-14 185-14 185/70-14 185/75-14 195/65-14 195/70-14 195/75-14 205/65-14 205/70-14	165/70-15 175/65-15 175/70-15 185/65-15 185/70-15 195/60-15 195/65-15 195/70-15 205/55-15 205/60-15	185/55-16 195/55-16 195/60-16 205/55-16		206200801
XL			205/65-15	215/55-16 205/60-16	225/45-17 205/50-17	206400001



SNOWGECKO
Adatta per la vettura
con pneumatici di
dimensioni normali

Scatola / Box 12



99073
**Espositore per punto vendita
36 coppie**

Assortimento consigliato:

- 5 misura S
- 12 misura M
- 12 misura L
- 7 misura XL

**Espositori forniti vuoti.
Prodotto da ordinarsi
separatamente.**





AutoSock è un tipo di dispositivo antiscivolo che mira ad aumentare l'attrito delle ruote su strade innevate e con presenza di ghiaccio:

- **facile e veloce da montare e rimuovere anche in condizioni meteorologiche avverse.**
- leggero e facile da riporre.
- comodo durante la guida, non provoca vibrazioni o rumori
- si centra da solo
- riutilizzabile e lavabile in lavatrice
- riciclabile ed ecologico, non reca danni all'ambiente
- non danneggia i cerchi
- incrementa l'efficienza dei sistemi elettronici di sicurezza (ABS, ESP, ETS, ASR, DSC)

2 pcs

CAMION

AUTOBUS

TRUCKS & BUSES



TRUCK

Camion di media e alta portata

Busta / Bag 12



GR.	MISURE PNEUMATICI / Tire SIZES			AUTOSOCK CAMION
	17.5"	19.5"	22.5"	
AL59	215/75-17.5 225/75-17.5 235/70-17.5 245/70-17.5			407601701
AL64	235/75-17.5	225/70-19.5		408001701
AL69		265/70-19.5 285/70-19.5 9.0-19.5		408751801
AL74			295/70-22.5 315/60-22.5	409601801
AL79			275/80-22.5 295/75-22.5 315/70-22.5	410101801
AL84			11-22.5 295/80-22.5 315/80-22.5	410501801

IMPORTANTE



Consultare il libretto di uso e manutenzione del veicolo e verificare le indicazioni relative al montaggio delle catene da neve

Le catene vanno sempre montate sulle ruote motrici. Se il veicolo è a trazione integrale consultare il libretto di uso e manutenzione



MIS. PNEUMAT. TIRE SIZES	CATENE CHAINS	CINGOLI SECTOR CHAINS		AUTO SOCK	MIS. PNEUMAT. TIRE SIZES	CATENE CHAINS	CINGOLI SECTOR CHAINS		AUTO SOCK	MIS. PNEUMAT. TIRE SIZES	CATENE CHAINS	CINGOLI SECTOR CHAINS		AUTO SOCK
		STANDARD	EUROPA				STANDARD	EUROPA				STANDARD	EUROPA	
6.70-13	20.5				12.0-22.5	37				35x11.5-16	29.6			
7.0-17.5	24	XS-2	1E		No Michelin XDE 2+ / XZY 2					35x12.5-15	35			
7.0-19.5	26	S-2	1E		12.0-22.5		XL-3	2E		35x12.5-16	35			
8-17.5	25	S-2	1E		12.0-22.5	32				35x12.5-17	35			
8-19.5	27	S-2	1E		Michelin XDE 2+ / XZY 2					36x13.5-15	36			
8-22.5		M-3	2E		12x80-20	31	XL-3	2E		38x14.00-20	36			
8.15-15 S.E.	24.6				12x80-22.5		XL-3	2E		41x14.00-20	37.3			
8.3-24	29				12.4-16	29.5				120/80-10	1			
8.3-28	31				12.4-20	37				120/80-12	1			
8.40-15	24.7				12.5-18	36				125-12	1			
8.5-17.5	26	S-2	1E		12.5-20	37	XL-3	2E		125-13	1			
9.0-15	25				12.5x80-18	36				125-15	4			
9.0-19.5		M-3	2E	AL69	12.5x80-20	37				125/80-12	1			
9.0-22.5	29	M-3	2E		13.0-20	38				130/80-12	1			
9.0x75-16	25				13.0-22.5	33	XL-3	2E		135-12	1			
9.5-16.5	26				13x75-22.5	37				135-13	2			
9.5-17	27				13x80-20	37	XL-3	2E		135-14	3			
9.5-17.5	27	S-2	1E		13.6-16	30				135-15	4			
9.5-19.5		M-3	2E		13.6-24	78				135/70-13	1			
9.5-20	27.7	M-3	2E		14x80-20	52				135/70-15	3			
9.5-22.5	29				14.5-20	52				135/80-12	1			
9.5-24	30	L-3	3E		14.75x80-20	38				135/80-13	2			
10.0-15	25.5				14.9-20	52				135/80-14	3			
10.0-16.5	25.8				15-19.5	37				140-12	2			
10.0-17.5	27.4				15-22.5	50.5				140/70-12	1			
10.0-20	31				Michelin XF					145-10	1			
10.0-22.5	30	L-3		AL79	15-22.5	52				145-12	2			
10-22.5			3E		No Michelin XF					145-13	3			
10.0-24	33				16-20	50.5				145-14	4			
10.0x75-15.3	25.8				16/70-20	50.5				145-15	5			
10x80-12	25.8				17.5-25	58.0				145/60-13	1			
10.5-18	27.7				18-22.5	53				145/65-13	2			
10.5-20	35.8				24x8.5-12	20.5				145/65-15	4			
10.5x80-18	27.7				24x8.5-14	20.5				145/70-12	1			
11.00-16	29.5				25x8.5-14	22				145/70-13	2			
11.0-20	32				27x8.5-12	24.6				145/70-14	3			
11.0-22	33				27x8.5-15	24.6				145/80-10	1			
11-22.5		XL-3	2E	AL84	28x9-15	24.5				145/80-12	2			
11.0-22.5	31			AL84	29x12-15	26.3				145/80-13	3			540-54
11x70-22.5	30				29x12.5-15	26.3				145/80-14	4			
11.2-24	37	XL-3	2E		29x13.5-15	26.4				150-12	2			
11.5x80-15.3	29.6				30x9.50-15	24.7				150/65-12	1			
12.0x12.5-18	35.8				31x10.5-15	25.5				155-10	1			
12.0-16	35				31x11.5-15	26.5				155-12	3			540-54
12.0-18	35.8-37				31x15.5-15	26.8				155-13	4			600
12.0-20	33				32x11.5-15	26.7				155-14	5			600
					33x12.0-18	29.6				155-15	6			
					33x12.5-15	29.6				155/60-13	2			
					33x12.5-16	29.6								
					33x12.5-17	29.6								

MIS. PNEUMAT. TIRE SIZES	CATENE CHAINS	CINGOLI SECTOR CHAINS		AUTO SOCK	MIS. PNEUMAT. TIRE SIZES	CATENE CHAINS	CINGOLI SECTOR CHAINS		AUTO SOCK	MIS. PNEUMAT. TIRE SIZES	CATENE CHAINS	CINGOLI SECTOR CHAINS		AUTO SOCK
		STANDARD	EUROPA				STANDARD	EUROPA				STANDARD	EUROPA	
155/60-14	3				175/75-16	22				195/75-14	22			645
155/60-15				540-54	175/80-13	6				195/75-15	22.5-9.5			685
155/65-13	2				175/80-14	20-7			645	195/75-16		XS-2	1E	695
155/65-14	3			54-540	175/80-15	21				195/75-16	22.5			
155/65-15	4.5				175/80-16	22				195/75-16	22.7			
155/70-12	2				180-15	9				195/75-16				
155/70-13	3			540-54	185-14	21-8			645	195/75-16				
155/70-14	4				185-15	22-9				195/75-16				
155/70-15	5			600	185-16	23	XS-2	1E		195/75-16				
155/80-10	1				185/50-15	4.5			54-540	195/75-16				
155/80-12	3			540-54	185/50-16	6			600-58	195/80-14	22-9			
155/80-13	4			540-54	185/55-13	3				195/80-15	10-22.5			685
155/80-14	5				185/55-14	4.5			540-54	195/80-16	23	XS-2	1E	
165-13	5			600-58	185/55-15	6			600-58	200-14	21			
165-14	19-6				185/55-16				620-62-600	200/70-16	22			
165-15	21				185/55-16	7.5				205-14	10-22.5			
165/50-15	3			540-54	185/55-16	6.5				205-16	24	XS-2	1E	
165/55-13	2				185/55-16	6.5				205/40-16	6			
165/55-14	3			540-54	185/55-16	6.5				205/40-17	7			605-600
165/55-15	4			540-54	185/60-13	4			540-54	205/40-18	8.5			
165/55-16	6				185/60-14	5			58-600	205/45-16	6.5			600-605
165/60-12	2				185/60-15	6.5			600-58	205/45-17	8			645
165/60-13	2				185/60-16	7.5				205/50-15	6.5			605-600
165/60-14	3			54-540	185/65-13	5			600-58	205/50-16	7.5			625-600-620
165/60-15	5			540-54	185/65-14	19-6			58-600	205/50-17	9			645
165/65-13	3			54-540	185/65-15	7			620-62-600	205/55-14	6.5			58-600
165/65-14	4			540-54	185/70-13	6			58-600	205/55-15	7.5			620-62-600
165/65-15	5				185/70-14	20-6.5			600-62-620	205/55-16	9			645
165/70-10	1				185/70-15	8			645	205/55-17	9.7			665-645
165/70-12	3				185/75-14	21				205/60-13	6			
165/70-13	4			540-54	185/75-16	22.5	XS-2	1E	685	205/60-14	7			600-58
165/70-14	5			600-58	185/80-14	21-8			645	205/60-15	8			645
165/70-15	6			600-58	185/80-15	22				205/60-16	9.5			665-645
165/75-14	19-6				185/80-16	23	XS-2	1E		205/65-14	21-8			645
165/80-13	5			600-58	195-14	22-9			685	205/65-15	22-9			645
165/80-14	19-6				195-15	10-22.5				205/65-16	22.5-9.7			685
170-13	5				195-16	23	XS-2	1E		205/65-17	23.5			695
170/60-15	5				195-16	23	XS-2	1E		205/65-17.5	24			
175-13	6			62-620-600	195/45-15	5			540-54	205/70-13	8			620-62-600
175-14	20-7				195/45-16	6			600-58	205/70-14	22-9			645
175-16	22				195/45-17				600-625	205/70-15	22.5-9.5			685
175/50-13	2				195/50-15	6			58-600	205/75-14	22.5			
175/50-14	3				195/50-16	7			58-600	205/75-15	22.5			695
175/50-15	4.5				195/55-13	4			54-540	205/75-16	23.5	XS-2	1E	695
175/50-16	6.5				195/55-14	5			58-600	205/75-17.5	24.7	S-2	1E	
175/55-15	5			58-600	195/55-15	6.5			600-58	205/80-14	10-22.5			
175/55-16	6			600	195/55-16	8			620-62-600	205/80-15	23			
175/60-13	3				195/60-13	5				205/80-16	24	XS-2	1E	
175/60-14	4.5			540-54	195/60-14	6			58-600	215-14	10-23			
175/60-15	6			600-58	195/60-15	7			62-620-600	215-15	24			
175/60-16	6.5			600-58	195/60-16	8			645	215-16	24.5	XS-2	1E	
175/65-13	4			540-54	195/65-13	6			58-600	215/35-17				605-600
175/65-14	5			600-58	195/65-14	7			62-600-620	215/40-16	6.5			600-605
175/65-15	6			600-620-62	195/65-14	7			620-620-620	215/40-17	8			605-600
175/70-12	3				195/65-15	21-8			645	215/40-18	9.5			645
175/70-13	5			600-58	195/65-16	22-9			665-645	215/45-16	7.5			605-600
175/70-14	6			58-600	195/70-13	7			58-600	215/45-17	9			645-625
175/70-15	7				195/70-14	21-8			645	215/45-18	9.7			645-665
175/75-13	6			600-58	195/70-15	22-9			645	215/50-15	7.5			
175/75-14	19-6.5				195/70-16	22.5-9.7				215/50-16	9			645
175/75-15				645						215/50-17	10			

MIS. PNEUMAT. TIRE SIZES	CATENE CHAINS	CINGOLI SECTOR CHAINS		AUTO SOCK	MIS. PNEUMAT. TIRE SIZES	CATENE CHAINS	CINGOLI SECTOR CHAINS		AUTO SOCK	MIS. PNEUMAT. TIRE SIZES	CATENE CHAINS	CINGOLI SECTOR CHAINS		AUTO SOCK
		STANDARD	EUROPA				STANDARD	EUROPA				STANDARD	EUROPA	
215/50-17 No Keber Krisalp	9.5				225/70-17	24.7			697	245/50-20	25.5			697
215/50-17				665-645	225/70-18				698	245/55-16	13			
215/50-18	12				225/70-19.5				AL64	245/55-17	14			
215/55-16	9.5			645	225/70-22.5		M-3	2E		245/55-18				697
215/55-17	10-22.7			685	225/75-15	24			697	245/55-19	25.5			
215/55-18	12.5-23.5			695	225/75-16	24.5	XS-2	1E	697	245/60-18	25			697
215/60-15	9			645	225/75-17.5	26	S-2	1E	AL59	245/65-17	25			697
215/60-16				685-665	235/35-18				645-625	245/70-16	25			697
215/60-16 No Continental Premium Contact 2 / No Michelin Primacy Energy Saver / No Bridgestone Duravis Rxxx	22.5-9.7				235/35-19	10			685-665	245/70-17	25.5			698
215/60-16 Continental Pre- mium Contact 2 / Michelin Primacy Energy Saver / Bridgestone Duravis Rxxx	10-22.7				235/40-17	9			645-625	245/70-17.5	27	S-2	1E	AL59
215/60-17	12.5-23.5			695	235/40-18	10			645	245/70-19.5	27.4	M-3	2E	
215/65-14	21				235/40-19	12				245/75-15				697
215/65-15	22.5-9.5			685-665	235/45-17	10			645	245/75-16	25.5			698
215/65-16	12-23			685	235/45-18	12			685	245/75-17	26.7			699
215/65-17	13-23.5				235/45-19	13-24			695	245/75-17.5	27	S-2	1E	
215/70-14	10-22			685-665	235/45-20	24.7				245/85-15				699
215/70-15	10-22.7			685	235/50-16	10				250-15	24.8			
215/70-16	23.5			695	235/50-17	12			685	250/70-15	24.8			
215/75-14	23			685	235/50-18	24			695	250/75-16 Nokian TRI-2	25.8			
215/75-15	23			695	235/50-19	24.7				250/80-16 Nokian TRI-2	27			
215/75-16	24	XS-2	1E	697	235/55-15	9.5			695	250/80-16	27.3			
215/75-17.5	25	S-2	1E	AL59	235/55-17	13-24			697	250/80-16 No Nokian TRI-2	25.8			
215/80-14	23				235/55-18	14-24.5			697	250/80-18	27.4			
215/80-15	24			697	235/55-19	25			697	255/30-19	12			
215/80-16	24.5	XS-2	1E	697	235/55-20	25.5			698	255/35-18	12			685
215/85-16	24.5	XS-2	1E	698	235/60-14	9.5				255/35-19	13			
225/35-17	7.5				235/60-15	10				255/35-20				695
225/35-18	9			645	235/60-16	13-23.5			695	255/40-16	24			
225/35-19				645	235/60-17	14-24.5			697	255/40-17	12			685
225/40-18	9.7			645	235/60-18	24.7			697	255/40-18	13			695
225/40-19	12-23			665-685	235/65-16				697	255/40-19	24			695
225/45-16	8.5				235/65-16 No Goodyear Cargo Ultra Grip 2	24.5				255/40-20	24.7			
225/45-17	9.5			645	235/65-16 Goodyear Cargo Ultra Grip 2	24				255/45-17	13			
225/45-18	10			685-665	235/65-17	24.7			697	255/45-18	13-24			
225/45-19	13-23.5				235/65-18	25.5			698	255/45-19	24.5			
225/50-15	8.5				235/65-18	25.5				255/45-20	25.5			697
225/50-16	9.5			645	235/70-15	13-24				255/50-19	25.5			697
225/50-17	10-22.7			665-685	235/70-16	14-24.7			697	255/50-20	26.5			698
225/50-18	13			685	235/70-17	25				255/50-21				698
225/55-14	8				235/70-17.5				AL59	255/55-17	24.7			
225/55-15	9				235/75-15	24.5			697	255/55-18	25.5			697
225/55-16	10			665-685	235/75-16	25			697	255/55-19	26.5			698
225/55-17	12.5-23			685	235/75-17.5	27	S-2	1E	AL64	255/55-20				698
225/55-18	13-24			695	235/80-16	25				255/60-15	24			
225/55-19	14-24.7			697	235/85-16	26.5			699	255/60-17	25.5			697
225/60-14	8.5				245/30-19				645	255/60-18	26.5			698
225/60-15	9.5			685-665	245/35-18	9.7			645	255/65-16	24.7-25			697
225/60-16	12-23			685	245/35-19	12			685	255/65-17	25.5			698
225/60-17	13-24			695	245/35-20	13			695	255/65-18				698
225/60-18	14-24.5			697	245/40-17	9.7			645	255/70-15	24.7			697
225/65-15	10				245/40-18	12			685	255/70-16	25.5			698
225/65-16	23.5			695	245/40-19	12.5			695	255/70-17				698
225/65-17	14-24.5			697	245/40-20	14-24.5			695	255/70-22.5	29			
225/65-18	25			697	245/45-16	10				255/75-15	25.5			698
225/70-15	23			695	245/45-17	12			665-685	255/100-16	35			
225/70-16	14-24			697	245/45-18	13-23.5			695	260/70-16	25.8			
					245/45-19	14-24.5			695	260/70-20	27.5			
					245/45-20	25			697	260/80-20	29			
					245/50-17				695	265/30-20	13			
					245/50-18	14-24.5				265/35-19	13			
					245/50-19	25				265/35-20	14			
										265/40-17	12			

MIS. PNEUMAT. TIRE SIZES	CATENE CHAINS	CINGOLI SECTOR CHAINS		AUTO SOCK	MIS. PNEUMAT. TIRE SIZES	CATENE CHAINS	CINGOLI SECTOR CHAINS		AUTO SOCK	MIS. PNEUMAT. TIRE SIZES	CATENE CHAINS	CINGOLI SECTOR CHAINS		AUTO SOCK
		STANDARD	EUROPA				STANDARD	EUROPA				STANDARD	EUROPA	
265/40-21	26.5			697	295/80-22.5	37				400-12	1			
265/45-20	26.5			697	No Michelin XDN2 Grip / No Michelin XDW Ice Grip / No Bridgestone M729					400-19		XS-2	1E	
265/45-21	26.5				295/80-22.5		XL-3	2E	AL84	400/55-22.5	37			
265/50-19	26.5			697	300/50-18	29.6				400/70-20	50.5			
265/50-20	26.7			698	300/65-18	29.6				405/70-18	50.5			
265/55-17				697	300/70-20	35.8				405/70-20	50.5			
265/55-18				697	300/70-24	31				420/65-20	50.5			
265/55-19	26.7			698	300/80-15.3	29.6				425/55-19.5	37			
265/60-18	26.5			698	300/80-24	37	XL-3	2E		445/65-22.5	53			
265/65-17	26.5			698	Nokian TRI-2					445/80-25	58.0			
265/65-18	26.7			699	305/60-22.5	30	L-3	3E-2E		500-10	1			
265/70-15	25			697	305/70-19.5	29.5	L-3	3E		500-12	2			
265/70-16	26.5			698	305/70-22.5	31	XL-3	2E		500/50-17	37			
265/70-17	26.7			699	305/75-24.5	32	XL-3	2E		520-14	5			
265/70-17.5	27.4				315/35-20	26.5				560-12	3			
265/70-19.5	27.5	M-3	2E	AL69	315/55-16	26.3				560-13	5			
265/75-15	25.5			698	315/60-22.5	30.5	XL-3	2E	AL74	560-14	5			
265/75-16	26.7			699	315/70-17	35				560-15	6			
270/75-15 Nokian TRI-2	25.8				315/70-22.5		XL-3	2E	AL79	590-13	5			
275/30-19	13				315/70-22.5	37				600-12	3			
275/35-18	12.5				315/70-22.5					600-13	7			
275/35-20	24.7				Michelin XDN2 Grip / Michelin Multiway 3D XDE / Bridgestone M729					600-14	9			
275/40-17	13				315/70-22.5	31				600-15	10			
275/40-19	24.7				No Michelin XDN2 Grip / No Michelin Multiway 3D XDE / No Bridgestone M729					600-16	23	XS-2	1E	
275/40-20	25.5			697	315/75-15	29.6				640-13	6			
275/45-19	25.5			697	315/75-16	29.6				640-15	21			
275/45-20	26.5				315/75-22.5	37	XL-3	2E		640-16	23	XS-2	1E	
275/55-17	25.5				315/75-24.5	33	XL-3	2E		650-14	20			
275/55-20	27.4				315/80-16	35				650-16	24	XS-2	1E	
275/60-17	26.5			698	315/80-22.5	32				650-16.5	24.5			
275/60-18	26.7				No Michelin XDN2 Grip					650-17	24.5			
275/65-17	26.7				315/80-22.5	33				650-20	27	S-2	1E	
275/65-18	27.4				Michelin XDN2 Grip					670-14	22			
275/65-20	35				315/80-22.5		XL-3	2E	AL84	670-15	23			
275/70-16	26.7				320/65-16	29.6				700-14	21			
275/70-19.5	35	M-3	2E		320/70-20	36				700-15	24-24.8			
275/70-22.5	30	L-3	3E		320/70-24	52				700-16	25	S-2	1E	
275/80-18	27.7				320/80-18	35.8				700-18		S-2	1E	
275/80-20	35.8				320/85-20	37				700-20	27			
275/80-22.5	31	XL-3	2E	AL79	335/80-18	36				750-14	23			
275/80-24.5				AL84	335/80-20	37	XL-3	2E		750-15	25			
280/70-16	26.5				340/75-20	37				750-16	26	S-2	1E	
280/70-20	27.7				340/80-18	36				750-18	27			
280/85-24	37				340/80-20	37				750-20		M-3	2E	
285/30-20	14				340/85-24	78				825-15	27			
285/45-19	26.5				355/80-20	52				825-16	27	S-2	1E	
285/50-18	25.5				360/60-24	37.3				825-17		M-3	2E	
285/55-18	26.7				360/70-20	37.3				825-20	29	M-3	2E	
285/60-22.5	29.5				360/70-24	77.5				890-15	10			
285/65-18	27.4				360/80-20	52				900-16	35			
285/70-17	27.4				365/70-18	36				900-20	30	L-3	3E	
285/70-19.5	35	M-3	2E	AL69	365/80-20	52				1000-20		XL-3	2E	
285/75-16	29.6				365/85-20	38				1100-20		XL-3	2E	
295/30-18	13				375/70-20	37				1100-22		XL-3	2E	
295/35-21	26.5				375/75-20	52				1200-20		XL-3	2E	
295/40-20	26.5				380/70-20	50.5								
295/55-22.5	35				380/75-20	52								
295/60-22.5	29.5	L-3	3E		385/65-22.5	52								
295/70-22.5	30	L-3	3E	AL74										
295/75-16	27.5													
295/75-22.5				AL79										



Ogni confezione contiene:

- Libretto plastificato con le istruzioni di montaggio
- Maglie di ricambio
- Guanti in plastica
- Certificato di omologazione

Each box contains:

- Plastic-coated instruction manual
- Spare links for repair
- PE gloves
- Copy of approval certificates.



Imballo da 3 serie

Imballo da 1 serie



In caso di smarrimento della confezione, è possibile risalire alla misura della catena leggendo le cifre stampate sul gancio verde (togliere lo zero dal codice stampigliato; esempio: 80 corrisponde alla misura 8)

In absence of box or label size of the chain can easily be identified by reading the number stamped on the green hook (remove the zero from the code; example number "80" correspond to size "8").

VAL D'AOSTA, PIEMONTE, LIGURIA (escluso La Spezia)

Concessionaria STELLA POLARE srl

Via Trecate, 30/32 - 10141 TORINO
Tel. 011/7792230 - Fax 011/7794276
dep_torino@lampa.it
info@stellapolareweb.com

Liguria: Raffetto Marco 348/3808300
Piemonte: Rosso Marco 338/1762940

LOMBARDIA

(BG - BS - CO - LC - MI - MB - SO - VA)

Zoni Daniele

Tel. 349/2544098 - Fax 0375/820730
daniele_zoni@lampa.it

Zoni Massimiliano

Tel. 328/2166119 - Fax 0375/820730
massimiliano_zoni@lampa.it

(PV - LO - CR - MN)

Sistici Luca

Tel. 327/6573409 - Fax 0375/820730
luca_sistici@lampa.it

VENETO, FRIULI, TRENTINO

SOVER s.r.l. - Salmaso Mario

Viale Europa, 14 - Zona Ind. Art.
35020 PONTE S. NICOLÒ (PD)
Tel. 049/8960533 - 8960534
Fax 049/8960538
dep_padova@lampa.it

Salmaso Mario 348/3054551

Salmaso Lorenzo 348/6429413

Costa Lino 337/729728

Pataro Enrico 348/5162211

Costa Herbert 347/8412935

LAMPA S.p.A.

Via Guido Rossa 53/55
46019 Viadana (MN)



Tel. 0375/820700
Fax 0375/820800
info@lampa.it
ordini@lampa.it

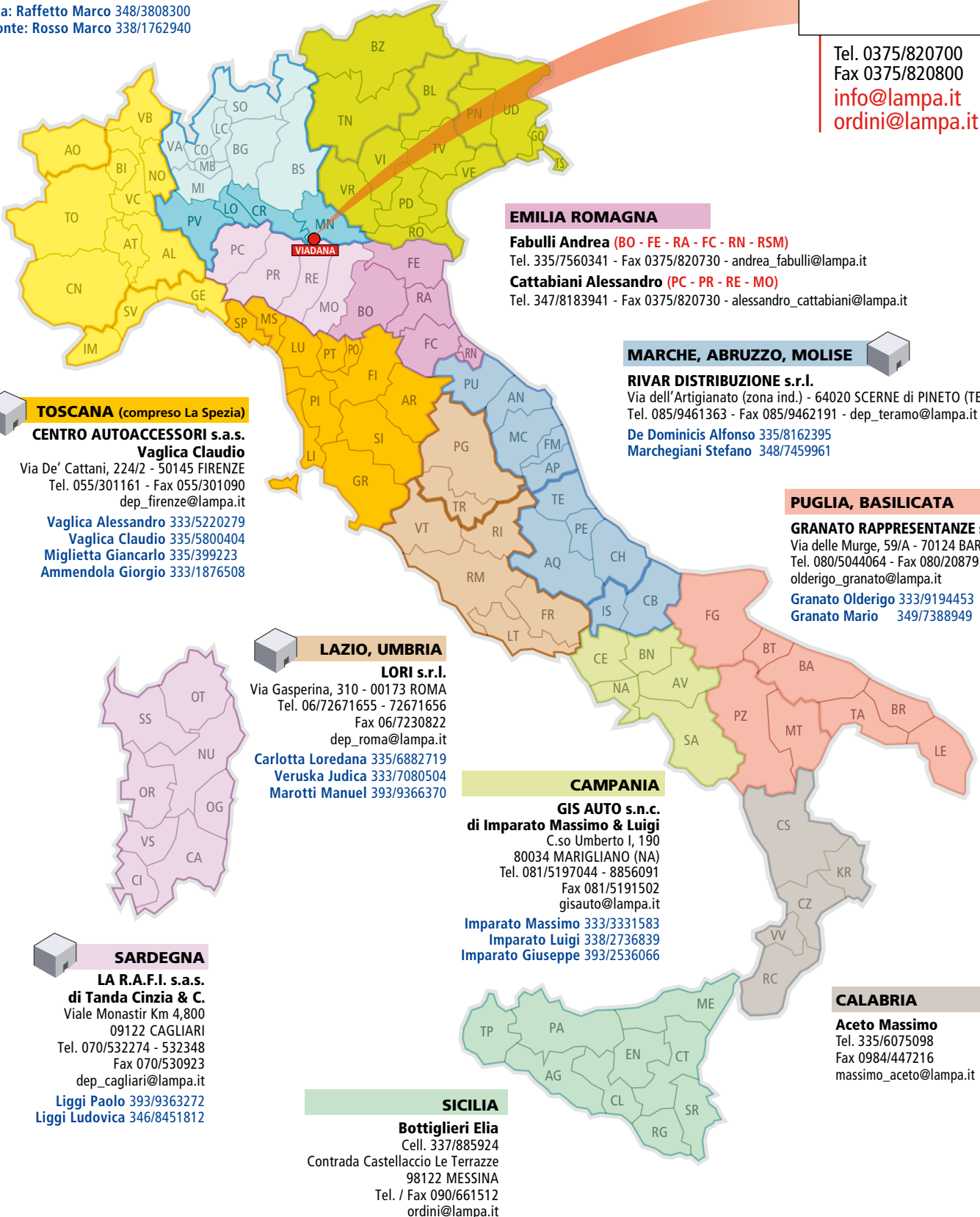

EMILIA ROMAGNA

Fabulli Andrea (BO - FE - RA - FC - RN - RSM)

Tel. 335/7560341 - Fax 0375/820730 - andrea_fabulli@lampa.it

Cattabiani Alessandro (PC - PR - RE - MO)

Tel. 347/8183941 - Fax 0375/820730 - alessandro_cattabiani@lampa.it

MARCHE, ABRUZZO, MOLISE

RIVAR DISTRIBUZIONE s.r.l.

Via dell'Artigianato (zona ind.) - 64020 SCERNE di PINETO (TE)
Tel. 085/9461363 - Fax 085/9462191 - dep_teramo@lampa.it

De Dominicis Alfonso 335/8162395

Marchegiani Stefano 348/7459961

PUGLIA, BASILICATA

GRANATO RAPPRESENTANZE s.a.s.

Via delle Murge, 59/A - 70124 BARI
Tel. 080/5044064 - Fax 080/2087911
olderigo_granato@lampa.it

Granato Olderigo 333/9194453

Granato Mario 349/7388949

LAZIO, UMBRIA

LORI s.r.l.

Via Gasperina, 310 - 00173 ROMA
Tel. 06/72671655 - 72671656

Fax 06/7230822

dep_roma@lampa.it

Carlotta Loredana 335/6882719

Veruska Judica 333/7080504

Marotti Manuel 393/9366370

CAMPANIA

GIS AUTO s.n.c.

di Imperato Massimo & Luigi

C.so Umberto I, 190
80034 MARIGLIANO (NA)
Tel. 081/5197044 - 8856091
Fax 081/5191502
gisauto@lampa.it

Imperato Massimo 333/3331583

Imperato Luigi 338/2736839

Imperato Giuseppe 393/2536066

SARDEGNA

LA R.A.F.I. s.a.s.

di Tanda Cinzia & C.

Viale Monastir Km 4,800
09122 CAGLIARI

Tel. 070/532274 - 532348

Fax 070/530923

dep_cagliari@lampa.it

Liggi Paolo 393/9363272

Liggi Ludovica 346/8451812

SICILIA

Bottiglieri Elia

Cell. 337/885924
Contrada Castellaccio Le Terrazze
98122 MESSINA

Tel. / Fax 090/661512

ordini@lampa.it

CALABRIA

Aceto Massimo

Tel. 335/6075098

Fax 0984/447216

massimo_aceto@lampa.it

LAMPA S.p.A.
Via Guido Rossa 53/55
46019 Viadana (MN)



Tel. 0375/820700
Fax 0375/820800
info@lampa.it
ordini@lampa.it

RESPONSABILE AGENTI
Leonardo Peppoloni
Tel. 392/4545158
peppolonileonardo@gmail.com



LOMBARDIA

(VA - CO - MB - LC - SO)

Enrico Pallottini
Tel. 366/1518905
enrico.pallottini@gmail.com

(PV - MI - LO - CR - BG - BS - MN)

Pierangelo Galizzi
Tel. 335/217043
galizzipier@gmail.com



VENETO, FRIULI, TRENTINO

Leonardo Peppoloni
Tel. 392/4545158
peppolonileonardo@gmail.com



PIEMONTE, VAL D'AOSTA

Enrico Pallottini
Tel. 366/1518905
enrico.pallottini@gmail.com

EMILIA ROMAGNA

 **Giacomo Di Lillo**
Tel. 388/7561189
giacky27ale2@live.it

 **Leonardo Peppoloni**
Tel. 392/4545158
peppolonileonardo@gmail.com

MARCHE, ABRUZZO, MOLISE

 **Leonardo Peppoloni**
Tel. 392/4545158
peppolonileonardo@gmail.com



CAMPANIA, PUGLIA, BASILICATA

Raoul Capuano
Tel. 329/6983492
raoulcp@yahoo.it



LIGURIA

Susanna Bortolotti
Tel. 328/3368151
bortolottisusanna@libero.it



TOSCANA

Giovanni Rindi
Tel. 342/1675680
rindigiovanni@gmail.com



UMBRIA

Carmen Jaramillo
Tel. 340/1608646
info@beautycaritalia.com



LAZIO

Alex Merli
Tel. 348/8561861
alex.merli@live.it



CALABRIA

Mario De Lorenzo
Tel. 335/242342
mariodelorenzo@diemmegroup.it



SARDEGNA

Leonardo Peppoloni
Tel. 392/4545158
peppolonileonardo@gmail.com



SICILIA

(ME - EN - CT - CL - RG - SR)
Alessandro Brillante
Tel. 333/6004080
alex73brillante@gmail.com

(TP - PA - AG)
Leonardo Peppoloni
Tel. 392/4545158
peppolonileonardo@gmail.com





Art. 99325
Catalogo Catene
Snow Chains Catalogue

8 000692 993255

MDS-R17-2016.09



www.snowdrive.it



Snow Drive[®]
TRACTION DEVICES

is a registered trademark of



LAMPA S.p.A.

Via G. Rossa, 53/55 - P.O. Box 115

46019 Viadana (MN) Italy

Tel. (+39) 0375 820700

Fax (+39) 0375 820800

✉ info@lampa.it - 🌐 www.lampa.it